

PREM

Most professional manufacturer of grooved fittings



ABOUT PREM

INTERNATIONAL APPROVAL



Certificate of Compliance

This certificate is issued for the following:

Non-Gasketed Pipe Fittings for Aboveground Fire Protection Systems

Model J02R
Grooved Outlet Welded Pipe Outlet

Model J01
Threaded Outlet Welded Pipe Outlet with either NPT or BSPT Threads

Prepared for:
Shandong Leide Machinery Co., Ltd
Fang Zhang Zi
Southeast of Yantai County
Tangshan City, Hebei Province 064100
China

Manufactured at:
Shandong Leide Machinery Co., Ltd
Fang Zhang Zi
Southeast of Yantai County
Tangshan City, Hebei Province 064100
China

FM Approvals Class: 1920 - "Pipe Couplings and Fittings for Aboveground Fire Protection Systems"
Approval Identification: 3058013
Approval Granted: July 22, 2016

To verify the availability of the Approved product, please refer to www.approvalguide.com

Said Approval is subject to satisfactory field performance, continuing Surveillance Audits, and strict conformity to the construction as shown in the Approval Guide, an online resource of FM Approvals.



David H. Fuller
AVP, Manager of Fire Protection
FM Approvals
1151 Boston-Providence Turnpike
Norwood, MA 02062 USA



CERTIFICATE OF COMPLIANCE

Certificate Number: 20160107-EX20961
Report Reference: EX20961-20160107
Issue Date: 2016-January-07

Issued to:
SHANDONG LEIDE MACHINERY CO LTD
No. 3998
West Weichuan N Rd
Weicheng District
Weifang
Shandong 261057 CHINA

This is to certify that representative samples of:

**FITTINGS, WELDED OUTLET
Model: J01, J02R**

Have been investigated by UL in accordance with the Standard(s) indicated on this Certificate.

Standard(s) for Safety: **UL 2188 WELDED OUTLET FITTINGS FOR FIRE PROTECTION, SCHEDULE 40S WELDED OUTLET FITTINGS**

Additional Information: See the UL Online Certifications Directory at www.ul.com/certguide for additional information

Only those products bearing the UL Certification Mark should be considered as being covered by UL's Certification and Follow-Up Services.

Look for the UL Certification Mark on the product.



Page 1 of 1



Certificate of Environment Management System

Form No. 010-000000
Issued to:
SHANDONG LEIDE MACHINERY CO., LTD.

Address:
Fang Zhang Zi
Southeast of Yantai County
Tangshan City, Hebei Province 064100
China

Standard(s): **ISO 14001:2015**

Approval Date: 2016-01-07
Approval Validity: 2016-01-07 to 2016-01-07

Beijing Zhonglianrun Certification Center





Certificate of Compliance

This certificate is issued for the following:

PIPE COUPLINGS AND FITTINGS FOR ABOVEGROUND FIRE PROTECTION SYSTEMS

Rigid and FLEXIBLE COUPLINGS
Models GKS (rigid), XGGT1 (rigid) and XGGT2 (flexible)
SIZES 1 through 10 inch NPS

MECHANICAL TEES
Model XGGT04
SIZES 1/4 through 8 inch NPS

GROOVED SPLIT FLANGES
Model XGGT09
SIZES 2-1/2, 3 and 4 inch NPS

Prepared for:
Shandong Leide Machinery Co., Ltd
No. 3998 West Weichuan N Road
Weicheng District
Weifang City, Shandong 261057
China

FM Approvals Class: 1920
Approval Identification: 3044463
Approval Granted: February 24, 2012

Said Approval is subject to satisfactory field performance, continuing Follow-up Facilities and Procedures Audits, and strict conformity to the construction as shown in the Approval Guide, an online resource of FM Approvals.

For more than 160 years FM Approvals has partnered with business and industry to reduce property losses.



Richard B. Dume
Group Manager - Fire Protection
FM Approvals
1151 Boston-Providence Turnpike
Norwood, MA 02062



CERTIFICATE OF COMPLIANCE

Certificate Number: 20140627-EX15228
Report Reference: EX15228-20140627
Issue Date: 2014-June-27

Issued to:
SHANDONG LEIDE MACHINERY CO LTD
NO.3998 WEST WEICHUAN RD
WEICHENG DISTRICT
WEIFANG, SHANDONG 261057 CHINA

This is to certify that representative samples of:

FITTINGS, RUBBER GASKETED
See addendum page

Have been investigated by UL in accordance with the Standard(s) indicated on this Certificate.

Standard(s) for Safety: **Rubber Gasketed Fittings for Fire-Protection Service, UL 2122**

Additional Information: See the UL Online Certifications Directory at www.ul.com/certguide for additional information

Only those products bearing the UL Listing Mark should be considered as being covered by UL's Listing and Follow-Up Services.

The UL Listing Mark generally indicates the following elements: the symbol UL in a circle with the word "LISTED" or "CLASSIFIED" (or any other applicable category) to UL, and the product category name (product identifier) as indicated in the appropriate UL Directory.

Look for the UL Listing Mark on the product.



Page 1 of 1



QUALITY MANAGEMENT SYSTEM CERTIFICATE

Certificate No.: 0111020000000000
Issued to:
Shandong Leide Machinery Co., Ltd.

Address:
Fang Zhang Zi
Southeast of Yantai County
Tangshan City, Hebei Province 064100
China

Standard(s): **ISO 9001:2008**

Approval Date: 2014-06-27
Approval Validity: 2014-06-27 to 2014-06-27

CHINA QUALITY CERTIFICATION CENTRE





Certificate of Compliance

This certificate is issued for the following:

Pipe Couplings and Fittings for Aboveground Fire Protection Systems

Models XGGT01, XGGT011, XGGT03, XGGT06, XGGT06, XGGT05, XGGT05, XGGT03, GKS, XGGT1, XGGT2, L922

Various sizes from 1-1/4 to 12 inch NPS

Prepared for:
Shandong Leide Machinery Co Ltd
No. 3998 West Weichuan N Road
Weicheng District
Weifang City, Shandong 261057
China

FM Approvals Class: 1920
Approval Identification: 0003049099
Approval Granted: 12/17/2013

Said Approval is subject to satisfactory field performance, continuing Follow-up Facilities and Procedures Audits, and strict conformity to the construction as shown in the Approval Guide, an online resource of FM Approvals.

To verify the availability of the Approved product, please refer to www.approvalguide.com



Richard B. Dume
Group Manager - Fire Protection
FM Approvals
1151 Boston-Providence Turnpike
Norwood, MA 02062

The standard in safety

File: 010128 Vol. 1 Issued: 2006/01/01 Revised: January 5, 2012

REGULATED SERVICE PROCEDURE
CLASS: C100

FITTINGS, RUBBER GASKETED
(UL 2122)

Manufacturer: SHANDONG LEIDE MACHINERY CO LTD
NO. 3998 WEST WEICHUAN RD
WEICHENG DISTRICT
WEIFANG, SHANDONG 261057 CHINA

Model(s): SURE 45 RUBBER/STEEL
(0001)0000

Listing: SURE 45 RUBBER/STEEL
(0001)0000



This Procedure authorizes the above manufacturer to use the marking specified by Underwriters Laboratories Inc. (UL) or an authorized licensee of UL, only on products covered by this Procedure, in accordance with the applicable UL Service Agreement.

The prescribed Mark or Marking shall be used only at the above manufacturing location on each product which complies with this Procedure and any other applicable requirements.

The Procedure contains information for the use of the above named Manufacturer and representatives of Underwriters Laboratories Inc. and is not to be used for any other purpose. It is not to be reproduced without the authorization of Underwriters Laboratories Inc. and is not to be used for any other purpose. It is not to be used for the manufacture of the equipment that is to be tested, either directly or indirectly, and that it will be returned to Underwriters Laboratories Inc. (UL) or an authorized licensee of UL, upon request.

This PROCEDURE, and any subsequent revision, is the property of Underwriters Laboratories Inc. (UL) and its authorized licensee of UL, and is not transferable.

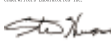
Underwriters Laboratories Inc.
Underwriters Laboratories Inc.

Stephen Bence
Senior Vice President
Global Regulatory Services Operations

William R. Conroy
Director
North American Certification Programs



The standard in safety

File: 010128 Vol. 1 Issued: 2006/01/01 Revised: January 5, 2012

(UL)0001 SERVICE PROCEDURE
CLASS: C100

FITTINGS, RUBBER GASKETED
(UL 2122)

Manufacturer: SHANDONG LEIDE MACHINERY CO LTD
NO. 3998 WEST WEICHUAN RD
WEICHENG DISTRICT
WEIFANG, SHANDONG 261057 CHINA

Model(s): SURE 45 RUBBER/STEEL
(0001)0000

Listing: SURE 45 RUBBER/STEEL
(0001)0000



This Procedure authorizes the above manufacturer to use the marking specified by Underwriters Laboratories Inc. (UL) or an authorized licensee of UL, only on products covered by this Procedure, in accordance with the applicable UL Service Agreement.

The prescribed Mark or Marking shall be used only at the above manufacturing location on each product which complies with this Procedure and any other applicable requirements.

The Procedure contains information for the use of the above named Manufacturer and representatives of Underwriters Laboratories Inc. and is not to be used for any other purpose. It is not to be reproduced without the authorization of Underwriters Laboratories Inc. and is not to be used for the manufacture of the equipment that is to be tested, either directly or indirectly, and that it will be returned to Underwriters Laboratories Inc. (UL) or an authorized licensee of UL, upon request.

This PROCEDURE, and any subsequent revision, is the property of Underwriters Laboratories Inc. (UL) and its authorized licensee of UL, and is not transferable.

Underwriters Laboratories Inc.
Underwriters Laboratories Inc.

Stephen Bence
Senior Vice President
Global Regulatory Services Operations

William R. Conroy
Director
North American Certification Programs

- MOST RELIABLE SUPPLIER -



Shandong lede Machinery Co.,Ltd was founded in 2003 with fixed assets \$20 million, LEDE owns 700 staffs and covers 200 thousand square meters which mainly engages in the production of grooved fittings and valves, the annual production capacity can reach 30,000 tons.

We are committed to supplying the high price-performance ratio products to the valued customers worldwide. LEDE products have been approved by FM, UL, CE, CNBOP, an LEDE will get VDS and LPCB together in 2017.

We own three big factories with advanced electric furnaces and automatic lines, all the products are machined with CNC and coated with epoxy powder, electrophoretic painting or galvanization. The mold center keeps developing new products which can satisfy diverse requirements from the customers.

Our products have been sold to most of the countries and areas in the world like America, South America, Europe, Russia, Canada, Australia, Middle East, Asia, Africa etc. Now LEDE products have been applied to many famous constructions. and LEDE has been one famous and respectable brand.



Casting Line



Warehouse



Our products are wildly used in various fields as follows:

1. Automatic sprinkler system for Fire Fighting Protection on Commercial, Civil and Municipal constructions like water supplying, gas supplying, heat supplying, drainage, air conditioning etc.
2. Industrial pipeline system on shipping, mine, oil field, textile, power plant, paper making, beverage and steel making etc.
3. Pipeline system on subway station, railway station , airport, seaport, bridge, channel etc.

PRODUCT CONTENTS



**MODEL 1512 STANDARD
RIGID COUPLING**

11



**MODEL GKS
RIGID COUPLING**

12



**MODEL XGQT1
RIGID COUPLING**

13



**MODEL XGQT4
PUSH-ON COUPLING**

14



**MODEL 31HP EXTRA HEAVY
RIGID COUPLING**

15



**MODEL XGQT2 LIGHT
FLEXIBLE COUPLING**

15



**MODEL 1212 HEAVY DUTY
FLEXIBLE COUPLING**

17



**MODEL XGQT3
REDUCING COUPLING**

18



**MODEL L991 GROOVED
FLANGE ANSI CLASS 125/150**

19



**MODEL XGQT09 GROOVED
FLANGE PN10/PN16**

19



**MODEL L981 FLANGE
ADAPTER CLASS 125/150**

20



**MODEL XGQT08 FLANGE
ADAPTER PN10/16**

20



**MODEL XGQT01L
90° ELBOW**

21



**MODEL XGQT011L
45° ELBOW**

21



**MODEL XGQT012
22-1/2° ELBOW**

21



**MODEL XGQT013
11-1/4° ELBOW**

21



**MODEL 2601
DRAIN ELBOW**

21



**MODEL XGQT01
SHORT RADIUS 90° ELBOW**

22



**MODEL XGQT011
SHORT 45° ELBOW**

22



**MODEL XGQT03
SHORT RADIUS TEE**

22



**MODEL XGQT03
BULLHEAD TEE**
22



**MODEL XGQT03L
TEE**
23



**MODEL XGQT05
CROSS**
23



**MODEL XGQT03R3
GROOVED REDUCING TEE**
24



**MODEL XGQT03S
THREADED REDUCING TEE**
25



**MODEL XGQT05
GROOVED REDUCING CROSS**
26



**MODEL XGQT05S
THREADED REDUCING CROSS**
27



**MODEL XGQT014
90° REDUCING ELBOW**
28



**MODEL 900
END-ALL FITTING**
28



**MODEL XGQT07 GROOVED
CONCENTRIC REDUCER**
29



**MODEL XGQT07S THREADED
CONCENTRIC REDUCER**
30



**MODEL XGQT06
END CAP**
31



**MODEL XGQT061
TRANSITION CAP**
31



**MODEL 1100 RING
JOINT COUPLING**
32



**PLAIN-END HDP
PIPING SYSTEM**
33



**MODEL 041 SADDLE-LET
(U bolt Mechanical Tee)**
34



**MODEL L922 SADDLE-LET
(Small Mechanical Tee)**
35



**MODEL XGQT04 MECHANICAL
TEE THREADED OUTLET**
36



**MODEL XGQT04G MECHANICAL
TEE GROOVED OUTLET**
38



**MODEL J01/J02R
OUTLET FITTING**
40





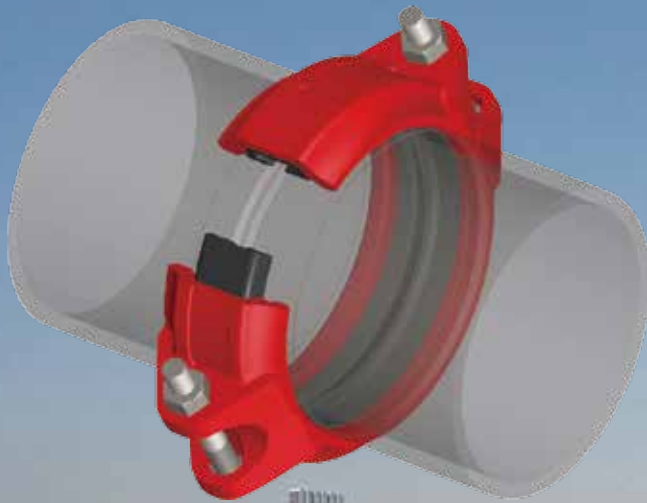

GROOVED PIPING SYSTEM

The grooved piping system is one of the most advanced, versatile, economical and reliable systems available today. After the pipe ends are grooved a gasket is stretched over the pipe ends. The coupling segments are then placed over the gasket and the bolts and nuts are fastened resulting in a secure and leak free joint.

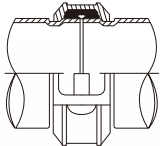
A coupling can be installed 3-4 times faster than a comparable welded or brazed joint and there is no need for a flame or welding torch on the job site. A coupling can be installed by fastening a pair of bolts and nuts while using only a wrench or spanner, whereas a comparable flanged joint requires the fastening of many bolts and nuts with a pair of wrenches. The grooved system allows for easy material take-offs and unlike a threaded system, there is no need to allow for added pipe length for thread engagement. With the removal of just a few bolts one can easily access the system for cleaning, maintenance, changes and or system expansion.

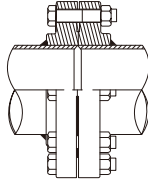
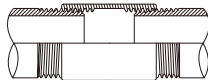

TYPICAL PIPE JOINING METHODS - QUICK COMPARISON

System Type	Grooved	Welded	Flanged	Threaded
Joint Construction				
Pipe End Preparation	Roll-grooving. Fast and easy	Beveled Ends	Welding of flanges by qualified welders	Threading by skillful operators is required
Equipment Required	Roll-grooving machine 	Welding equipment 	Welding equipment 	Pipe threading machine 
Installation	Easy fastening of bolts & nuts using only a wrench or spanner	Welding tools and supplies required on the jobsite. A skillful and proper weld can be time consuming.	A minimum of two wrenches or spanners required. Time consuming to tighten many bolts and nuts.	Pipe wrench required. As the pipe size increases so does the difficulty and force required for proper installation.
Allowance For Axial Displacement And Deflection	Yes - Couplings can allow for both.	No	No	No
Required Space For Installation	Can be installed in small spaces.	Adequate space is necessary for welding tools and welding around the entire O.D. of the pipe.	Adequate space is required as the flange O.D. is large and the wrenches require ample working space.	Adequate space is required for turning the pipe wrench.
Surface Corrosion Resistance	Easy to apply anti-corrosive paint	Difficult - Hard to paint inside of the pipe after welding	Easy to apply anti-corrosive paint	Easy to paint outside of the pipe after installation but inside threads are vulnerable to corrosion.
Ease of Prefabrication	Very Easy	Difficult	Difficult	Difficult
Quality Control	Product quality is easily controlled at the factory and or job site. Installation can be visually checked.	Quality of job site welding can be inconsistent. X-ray inspection may be required.	Quality of job site welding can be inconsistent.	Varies depending on skills of workers on the jobsite as all work is usually performed on site.
Maintenance and or Disassembly	Easy to dismantle and reinstall. System is flexible and forgiving.	Very difficult as no option but to cut away	Very difficult to dismantle and re-install due to limited space.	Difficult due to thread engagement, thread corrosion, limited space and need for a union.
Design & Cost Estimating	Easy take-offs and estimating. Most materials can be pre-fabricated.	Labor is difficult to estimate as the individual skill levels of welders is a determining factor.	Labor is difficult to estimate as the skill levels of welders and very accurate make-up is a determining factor.	Labor is difficult to estimate because prefabrication is not possible, all work is performed on the job site.

RIGID OR FLEXIBLE?

The grooved couplings are classified into two types, flexible and rigid. What are the differences? When and where should they be used? The following information is intended for system designers and installers to better understand the nature of the grooved piping systems. This will allow the designer and installer to make better use of the design features and advantages of grooved piping components and systems.

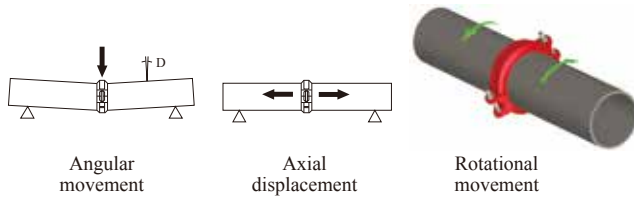

Type	Angular Movement deg.	Axial Displacement mm	Rotation after installation	Model Nos.
Flexible Coupling	≥1°	1.6 - 3.2	Yes	XGQT2, XGQT3 1212

Note: 1) Angular movement of flexible coupling 8" and larger sizes should be 0.5°. 2) Axial displacement data based on roll-grooved pipe.

RIGID COUPLINGS

The most popular and most widely used couplings today

The rigid couplings can be used in applications where you require a rigid joint similar to that of a traditional flanged, welded and or threaded connection. You need not worry about the snaking of the pipe on straight runs, as all Lede rigid couplings utilize both a mechanical and frictional interlock design to provide rigidity. Rigid couplings eliminate or reduce undesired angular movement, axial displacement and rotation after installation as is required under normal service conditions. Rigid couplings are some of the most popular and most widely used today.

Lede offers two different types of rigid couplings, the angle-pad design, the T&G (tongue and groove) design.

- **Angle-pad design:** As the bolts are tightened, the angled bolt pads slide in opposite directions causing the couplings keys to tightly grip the pipe, while at the same time the pipe grooves are forced outward against the coupling keys.



- **T&G design:** The T&G (tongue & groove) mechanism provides a mechanical and frictional interlock resulting in a rigid joint which reduces undesired angular movement. Lede T&G design allow tiny gap between two coupling segments after installed on grooved pipe.

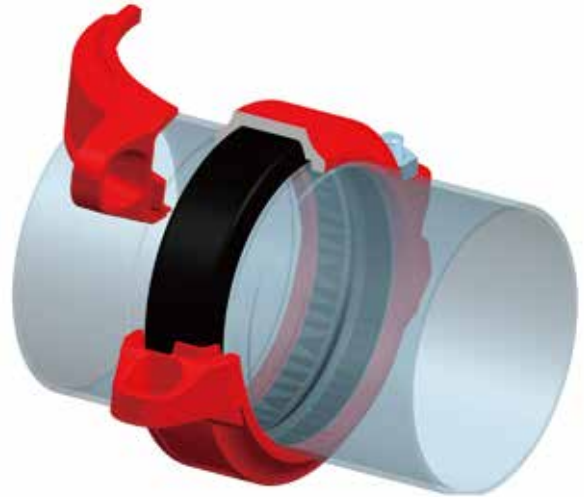

FLEXIBLE COUPLINGS

The flexible couplings allow for full design features in applications such as curved or deflected layouts and or when systems are exposed to outside forces beyond normal static conditions such as seismic events or where vibration and or noise attenuation are a concern. The ability to design in controlled flexibility is an advantageous feature when compared to traditional rigid joining methods such as threading, flanging and welding. When designing with flexible couplings you must allow for proper support to the system so as to eliminate undesired stress (**see Anchoring, hanging and supports on page 48**).

There are several published standards and codes covering grooved piping component. These codes or standards may vary as to the definition or standard for flexible couplings. System designers should confirm which standard (s) and or code(s) are required for the system being designed and they should select the applicable coupling for the application.

NFPA 13 defines a flexible coupling as;

“a listed coupling or fitting that allows axial displacement, rotation, and at least 1 degree of angular movement of the pipe without inducing harm on the pipe. For pipe diameters of 8 in. and larger, the angular movement shall be permitted to be less than 1 degree but not less than 0.5 degrees.” (NFPA 13-2007 3.5.4)

For sprinkler systems, NFPA 13 specifies the use of flexible couplings to protect the system against damage from earthquakes and sets some specific examples of how

and where they should be used. Designers and installers should design their fire protection systems in compliance with this standard. See Typical Applications – Flexible Couplings on Page 44.



Flexible Coupling

Axial Displacement & Angular Movement (Models XGQT2 & 1212)

Size		Axial Displacement mm/in	Angular Movement (Deflection)		Size		Axial Displacement mm/in	Angular Movement (Deflection)	
Nom. Size mm/in	Actual OD mm/in		Per coupling degrees	Per pipe mm/m, in/ft	Nom. Size mm/in	Actual OD mm/in		Per coupling degrees	Per pipe mm/m, in/ft
20	26.7	1.6	6°-46'	118	150	159.0	3.2	2°-18'	40
0.75	1.050	0.0625		1.42	6	6.250	0.125		0.48
25	33.4	1.6	5°-30'	96	150	165.1	3.2	2°-14'	39
1	1.315	0.0625		1.16	6	6.500	0.125		0.47
32	42.4	1.6	4°-20'	76	150	168.3	3.2	2°-10'	38
1.25	1.660	0.0625		0.91	6	6.625	0.125		0.45
40	48.3	1.6	3°-48'	66	200 JIS	216.3	3.2	1°-42'	30
1.5	1.900	0.0625		0.80	8	8.516	0.125		0.36
50	60.3	1.6	3°-01'	53	200	219.1	3.2	1°-40'	29
2	2.375	0.0625		0.63	8	8.625	0.125		0.35
65	73	1.6	2°-30'	44	250 JIS	267.4	3.2	1°-22'	24
2.5	2.875	0.0625		0.52	10	10.528	0.125		0.29
65	76.1	1.6	2°-24'	42	250	273.0	3.2	1°-20'	23
2.5	3.000	0.0625		0.50	10	10.750	0.125		0.28
80	88.9	1.6	2°-04'	36	300 JIS	318.5	3.2	1°-10'	20
3	3.500	0.0625		0.43	12	12.539	0.125		0.25
90	101.6	1.6	1°-48'	31	300	323.9	3.2	1°-08'	20
3.5	4.000	0.0625		0.38	12	12.750	0.125		0.24
100	108.0	3.2	3°-24'	59.0	350	355.6	3.2	1°-02'	18
4	4.25	0.125		0.71	14	14.000	0.125		0.22
100	114.3	3.2	3°-12'	55	400	406.4	3.2	0°-54'	16
4	4.500	0.125		0.67	16	16.000	0.125		0.19
125	127.0	3.2	2°-53'	50.0	450	457.0	3.2	0°-48'	14
5	5.000	0.125		0.60	18	18.000	0.125		0.17
125	133	3.2	2°-46'	48	500	508.0	3.2	0°-44'	13
5	5.250	0.125		0.58	20	20.000	0.125		0.15
125	139.7	3.2	2°-37'	46	550	559.0	3.2	0°-38'	11
5	5.500	0.125		0.55	22	22.000	0.125		0.13
125	141.3	3.2	2°-36'	45	600	610.0	3.2	0°-36'	10
5	5.563	0.125		0.54	24	24.000	0.125		0.13

Note: Axial displacement is the maximum value when the system is pressurized to the maximum working pressure.
Angular movement is the maximum value that a coupling allows under no internal pressure.

THE RING JOINT PIPING SYSTEM

An ideal pipe joining method where pipe is difficult to groove or when welding is not the preferred joining method

The processing of a roll groove on pipe becomes more difficult as the pipe O.D. and or wall thickness increases. Roll grooving pipe large than 14" (350mm) can be difficult and requires the proper tools and equipment. Pipe having a wall thickness greater than 0.375" (9.5mm) may not be practical to roll groove. In such cases the Lede ring joint piping system offers an excellent alternative.

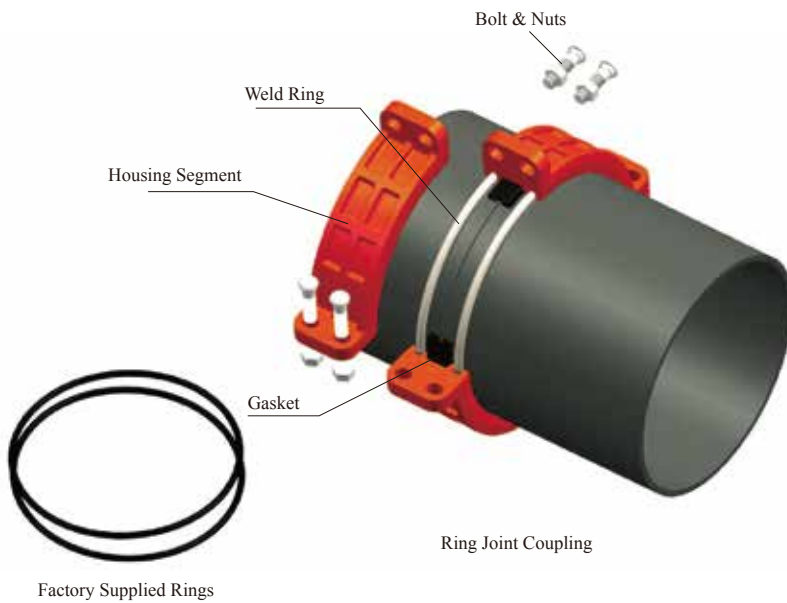

First weld a factory-supplied ring on each pipe end. Next mount the rubber gasket over the pipe ends and place the coupling segments over the gasket and fasten the bolts and nuts. The same C-shaped style gasket as used in the grooved system effectively seals the pipe ends. Rings can be welded in the fabrication shop or in the field and the coupling housings can be installed on the job site.

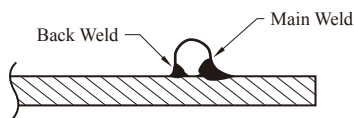

The **Model 1100 ring joint coupling** provides a much more secure joint than a comparable roll-grooved system, simply because the contact area of the rings is much greater than that of the roll groove profile. In addition the welded rings are able to withstand 2-3 times the shearing forces of roll grooves.

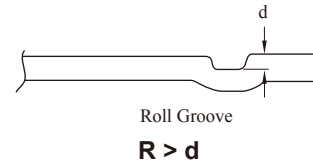
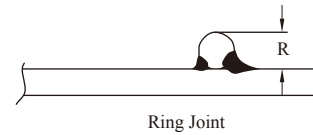

Ring welding requires only a structural weld, which, unlike pipe to pipe direct welding or flange welding, does not directly affect the sealing capability of the joint, thus eliminating the need to inspect the weld for leaks.

The ring joint coupling is classified as a Type II Class 1 mechanical coupling of ASTM F1476 and also meets or exceeds the design and performance requirements of AWWA C606.

- Applicable to plain-end and or beveled-end pipe
- The weld rings provide much better pressure restraint than that of a roll-grooved joint – 24 bars/350 psi working pressure for 350mm to 600mm/14" to 24"
- Factory supplied weld rings are much more economical than type A, B, C, D, E or G shoulder rings
- No inside protrusion or flare at the pipe end as is often seen in a roll-grooved joint
- The wide housing segments assembled with two bolts and nuts at each segment provide a positive grip of the pipe.

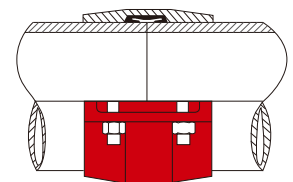
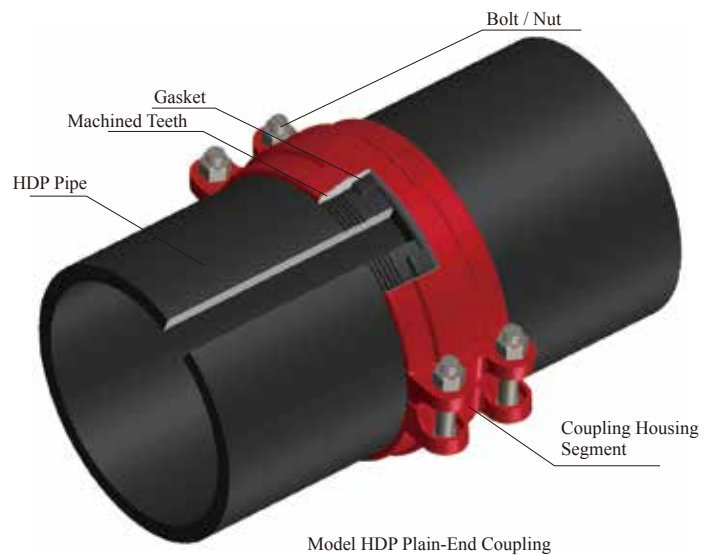
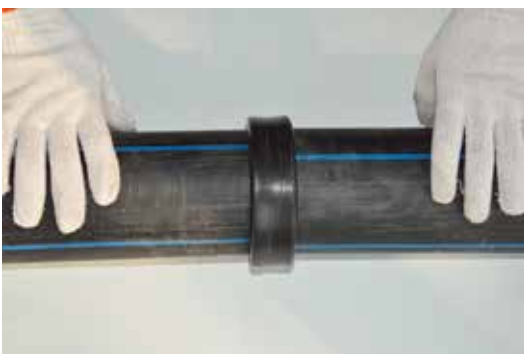
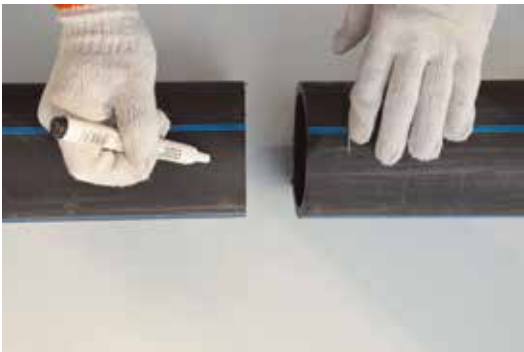

Plain-End HDP Coupling

The HDP series couplings provide fast and easy installation of HDP (high density polyethylene or polybutylene) pipe. A series of sharply machined teeth positively grip the HDP pipe. The C-shaped gasket effectively seals the pipe ends. These couplings can eliminate the need for costly heat fusion equipment, solvent joining and complicated and or expensive adapters.

- Recommended for HDP pipe, SDR 32.5-7.3
- Not recommended for PVC or other materials
- Pressure ratings are limited to the SDR of the HDP pipe being connected (HDP couplings are designed to hold much higher pressures than the HDP pipe being connected).
- Available in size 2" through 12" (63mm through 315mm)

HOLE-CUT PIPING SYSTEMS

The **hole-cut piping systems** provide a fast and easy mid-point branch outlet, eliminating the need for multiple fittings and allows for easy expansion of the piping system.

The **mechanical tees Models** XGQT04G, XGQT04 and L922 provide an easy take-out of a branch outlet without the need for welding. First a hole is cut or drilled at the desired location. The mechanical tee is then positioned so that the built-in locating collar fits within the hole. As the housing bolts are tightened, the pressure responsive gasket forms a leak-tight seal.



$$3 + 1 = 1$$

Couplings Reducing Tee Mechanical Tee

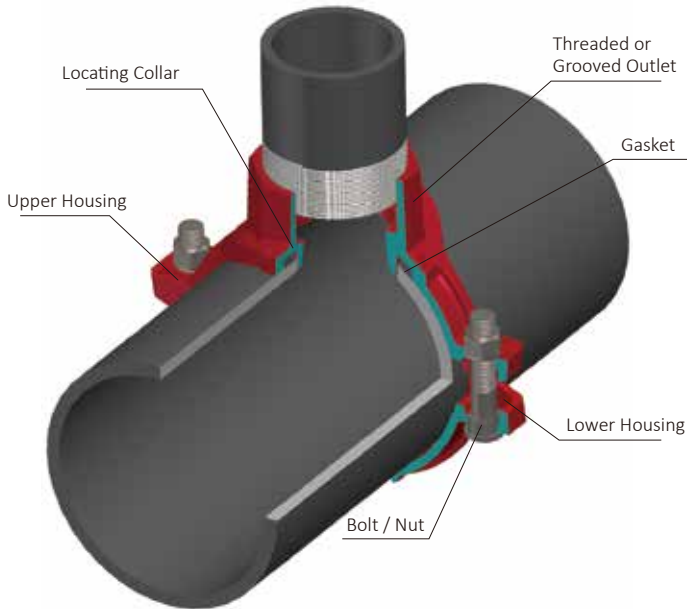

Model XGQT4 Mechanical Tee

- Grooved-end and threaded outlets are available
- A mechanical cross connection can be made by combining two upper housing segments



Model XGQT4C

The **Model 041 Saddle-Let** mechanical tee is the ideal outlet fitting for direct connection to sprinkler heads, short risers, drops and or gauges.

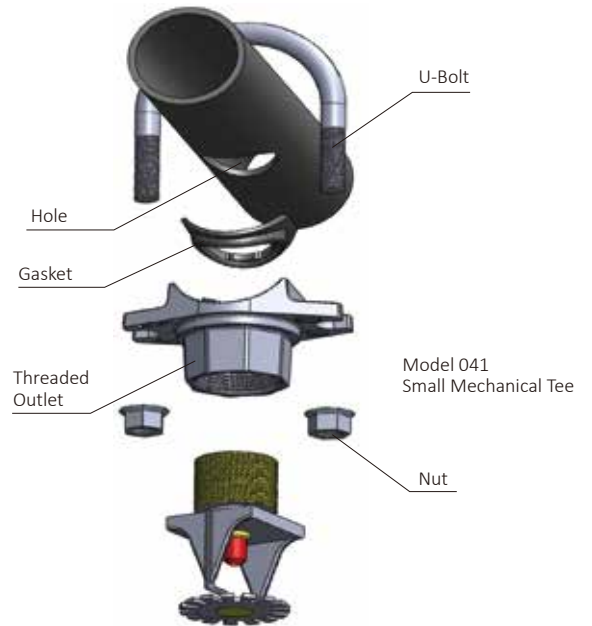

Welding Outlet Fittings

The **welding outlet fittings** provide an easy threaded outlet at any desired location along the header.

The **Model J01 universal outlet fitting** is designed to fit a range of header sizes which will reduce costs associated with ordering, inventory and installation. The model J01 was designed for the fire protection industry where a high volume of 1/2", 3/4" and 1" sizes are used. These outlets can be welded manually or with automated equipment.

- Meets NFPA 13 requirements, UL listed and FM approved
- The hole template is available for manual hole cutting
- Reduces welding time and the likelihood of burn through
- Reduces stock numbers by up to 70% over traditional outlets



For more sizes and or grooved outlets, please see our Models J01 and J02R outlets.

MATERIALS

HOUSINGS

The housing segments not only provide significant strength to the joint but they also compress and protect the gasket from exposure. Lede coupling housings and components are cast in a variety of materials as shown below.



Ductile Iron: Standard coupling housings and fittings are made of ductile iron conforming to ASTM A536 Gr. 65-45-12. The properties of Grade 65-45-12 ductile iron are as follows; 65,000 psi (448 MPa) tensile strength, 45,000 psi (310 MPa) yield strength and 12% elongation. As an

option we also offer ductile iron made to ASTM A395 Gr. 60-40-18, for applications where required or where boiler codes may apply.



Stainless Steel: We offer a variety of stainless steel casting materials depending on your intended application. Standard coupling housing and fitting materials include CF8 (304), CF8M (316) or CF3M (316L) per ASTM A743. Optional

materials include 2205 Duplex, 2507 Super Duplex and ASTM CK-3MCuN (UNSJ93245), equivalent to 254SMO*.

(* 254SMO is a registered trademark of Avesta Polarit AQB.)

GASKETS

Our gaskets are available in a variety of configurations and compounds to meet your specific requirements. These gaskets have excellent self sealing capabilities and



are designed to provide a leak tight seal. During assembly the gasket is first stretched over the pipe ends which forms the initial seal. As the housing segments are installed and secured the pressure responsive gasket is slightly compressed to form a leak-tight joint. The strength of the seal is further enhanced by internal line pressure that creates downward pressure on the lips of the gasket. The gasket also seals well under vacuum conditions up to 10 inHg (254 mmHg) which may occur when a system is drained. Please refer to the Gasket Selection Guide for additional details and gasket materials.

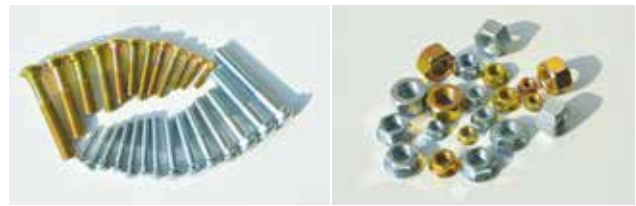

BOLTS AND NUTS

Our products utilize oval neck track bolts and heavy duty hex nuts, available either in UNC threaded or ISO metric threaded. The oval neck track bolts mate into the oval holes in the housing segments to allow for easy tightening using only a single wrench/spanner. The UNC bolts and nuts are electro zinc plated in a silver chromate color and ISO bolts and nuts in a gold chromate color. Hot-dip galvanized bolts and nuts are also available upon request. (M10 to M22 only)

Stainless steel track bolts and nuts, type 304 or 316, are supplied with Lede stainless steel couplings. Stainless steel track bolts and nuts are molybdenum disulfide (MoS₂) coated to inhibit galling.



A stainless steel bolt fastened with a silicone bronze nut

DATA CHART NOTES

Nominal Size mm/in	Pipe O.D. mm/in	Max.Working Pressure Bar/PSI	Max.End Load kN/Lbs	Axial Displacement mm/in	Angular Movement		Dimensions			Bolt Size in	Bolt Torque N-m/Lbs-Ft
					Degree Per Coupling(°)	Pipe mm/m in/ft	A mm/in	B mm/in	C mm/in		
1	2	3	4	5	6		7			8	9

- 1 **Nominal Size:** Our couplings and fittings are identified by the nominal IPS pipe size in inches or nominal diameter of pipe (DN) in millimeters.
- 2 **Pipe OD:** Actual outside diameter of pipe in inches and millimeters.
- 3 **Maximum Working Pressure:** Maximum working pressures listed are CWP (cold water pressure) or maximum allowed working pressure within the service temperature range of the gasket used in the coupling, based on standard wall or sch. 7/10/40 steel pipe, cut or roll-grooved to ANSI/AWWA C606-04 specifications.
These ratings may occasionally differ from maximum working pressures listed and/or approved by UL, ULC, and/or FM as testing conditions and test pipes differ. For performance data on other pipe schedules contact Lede.
Note: For one time field test only the maximum joint working pressure may be increased 1.5 times the figures shown.
- 4 **Maximum End Load:** Maximum end loads listed are total of internal and external forces to which the joint can be subjected, based on standard wall or sch. 7/10/40 steel pipe, cut or roll-grooved to ANSI/AWWA C606-04 specifications.
- 5 **Axial Displacement:** Designed range of the gap between pipe ends based on roll grooved pipe.
- 6 **Angular Movement (Deflection):** Maximum allowable deflection of pipe from centerline when the joint is used with cut or roll-grooved steel pipe under no internal pressure.
- 7 **Dimensions:** "A", "B", "C" and so on are external dimensions for reference purpose only in millimeters and inches.
- 8 **Bolt Size:** UNC bolt size and length in inches and ISO metric bolt size and length in millimeters with numbers of bolts where applicable.
- 9 **Bolt Torque:** Recommended bolt fastening torque in Lbs-Ft and N-m.

GENERAL NOTES

Service Fluid and Temperature: Service fluid and temperature limitations for Lede couplings are primarily governed by the gasket used within the coupling. Always refer to and consult the Lede Gasket Selection Guide.

Working Pressure: Our grooved couplings are generally engineered for use with standard or sch. 7/10/40 steel pipes (except for some high pressure models) and can be used within the rated working pressures as shown in the Lede literature. A one time only field test at 1.5 times the working pressure is allowed.

As there are limitations in service temperatures, the Lede couplings and fittings do not adopt the ANSI temperature-pressure ratings (Class 150, Class 300, etc.), ISO or JIS methods of pressure ratings (PN10, PN16, JIS 10K or 20K, etc.). All the published working pressures are CWP, non-shock cold water pressures, unless otherwise specified. Actual allowed working

pressures for a specific coupling will vary depending on the coupling size, pipe material, pipe schedule (or thickness) and types of grooves used. Special attention is required when using thin wall stainless steel pipe such as sch. 5. For further details request the performance data for specific thin wall pipe.

The dimensions, weights, performance data, and other specifications shown in this catalog supersede all previous published data. Lede reserves the right to change product designs and or specifications without notice and without obligation.

Illustrations shown within this catalog are for illustrative purposes. They are not drawn to scale and may have been exaggerated for clarity. Any person who makes use of the information or materials contained herein shall do so at their own risk and shall be liable for any results arising from such use.

MODEL 1512 STANDARD RIGID COUPLING

- Angle-Pad Design -

The Model 1512 is an angle-pad design standard rigid coupling for general piping applications where rigidity is required including valve connections, mechanical rooms, fire mains and long straight runs. The angle-pad design allows the coupling housings to slide along the bolt pads when tightened. The result is an offset clamping action which provides a rigid joint that resists flexural and torsional loads. Support and hanging requirements correspond to ANSI B31.1, B31.9 and NFPA 13.

Sizes available: 32mm-300mm / 1-1/4"~12"
 Working Pressure: Up to 35 bar / 500 psi

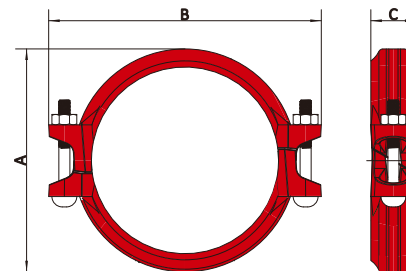

Nominal Size mm/in	Pipe O.D. mm/in	Max.Working Pressure Bar/PSI	Max.End Load KN/Lbs	Axial Displacement mm/in	Dimensions			Bolts Size	
					A mm/in	B mm/in	C mm/in	No.	mm/in
32	42.4	35	2.92	0-1.6	64	106	47	2	M10×60
11/4	1.669	500	656	0-0.06	2.52	4.17	1.85		3/8×2-3/8
40	48.3	35	3.79	0-1.6	69	113	47	2	M10×60
11/2	1.9	500	852	0-0.06	2.72	4.45	1.85		3/8×2-3/8
50	60.3	35	9.84	0-1.7	88	122	47	2	M10×60
2	2.375	500	2212	0-0.07	3.46	4.80	1.85		3/8×2-3/8
65	73	35	14.64	0-1.7	100	142	47	2	M12×70
21/2	2.875	500	3240	0-0.07	3.94	5.59	1.85		1/2×2-3/4
65	76.1	35	15.68	0-1.7	101.6	142	47	2	M12×70
21/2	3	500	3523	0-0.07	4.00	5.59	1.85		1/2×2-3/4
80	88.9	35	21.39	0-1.7	116	158	47	2	M12×70
3	3.5	500	4808	0-0.07	4.57	6.22	1.85		1/2×2-3/4
100	114.3	35	35.36	0-4.1	144.4	194	51	2	M12×70
4	4.5	500	7948	0-0.16	5.69	7.64	2.01		1/2×2-3/4
125	139.7	35	52.83	0-4.1	171.6	230	52	2	M16×85
5	5.5	500	11874	0-0.16	6.76	9.06	2.05		5/8×3-1/3
125	141.3	35	48.59	0-4.1	172	231	52	2	M16×85
5	5.563	500	10930	0-0.16	6.77	9.09	2.05		5/8×3-1/3
150	165.1	35	66.33	0-4.1	198	255	53	2	M16×85
6	6.5	500	14920	0-0.16	7.80	10.04	2.09		5/8×3-1/3
150	168.3	35	76.67	0-4.1	200	256	53	2	M16×85
6	6.625	500	17233	0-0.16	7.87	10.08	2.09		5/8×3-1/3
200	216.3	35	126.64	0-3.2	265	334	63	2	M20×120
8	8.515	500	28465	0-0.13	10.43	13.15	2.48		3/4×4-3/4
200	219.1	35	129.94	0-3.2	263.4	334	63	2	M20×120
8	8.625	500	29206	0-0.13	10.37	13.15	2.48		3/4×4-3/4
250	267.4	35	193.55	0-3.2	317	396	65	2	M22×190
10	10.527	500	43502	0-0.13	12.48	15.59	2.56		7/8×7-1/2
250	273	35	201.74	0-3.2	326	404	65	2	M22×190
10	10.75	500	45344	0-0.13	12.83	15.91	2.56		7/8×7-1/2
300	318.5	35	274.59	0-3.2	375	464	65	2	M22×190
12	12.539	500	61718	0-0.13	14.76	18.27	2.56		7/8×7-1/2
300	323.9	35	283.98	0-3.2	381	468	65	2	M22×190
12	12.75	500	63828	0-0.13	15.00	18.43	2.56		7/8×7-1/2

MODEL GKS RIGID COUPLING

- Angle-Pad Design -

The Model GKS is an angle-pad design standard rigid coupling for moderate pressure piping services including fire mains, long straight runs and valve connection. The angle-pad design allows the coupling housings to slide along the bolt pads when tightened. The result is an offset clamping action which provides a rigid joint which resists so-called 'snaking' of a long straight run. Support and hanging requirements correspond to ANSI B31.1, B31.9 and NFPA 13.

With the removal of only one bolt you can make a fast and easy 'swing-over' installation.

Sizes available: 32mm-400mm / 1-1/4"~16"

Working Pressure: Up to 20 bar / 300 psi

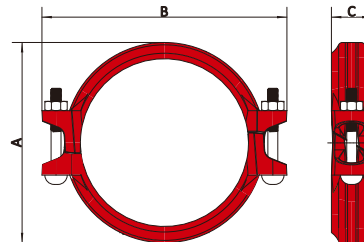

Nominal Size mm/in	Pipe O.D. mm/in	Max.Working Pressure Bar/PSI	Max.End Load KN/Lbs	Axial Displacement mm/in	Dimensions			Bolts Size mm/in
					A mm/in	B mm/in	C mm/in	
25	33.7	20	1.80	0-1.6	56	96	47	M10x55
1	1.327	300	405	0-0.06	2.20	3.78	1.85	3/8x2-1/8
32	42.4	20	2.92	0-1.6	64	106	47	M10x60
11/4	1.669	300	656	0-0.06	2.52	4.17	1.85	3/8x2-3/8
40	48.3	20	3.79	0-1.6	69	113	47	M10x60
11/2	1.9	300	852	0-0.06	2.72	4.45	1.85	3/8x2-3/8
50	60.3	20	5.91	0-1.6	88	122	47	M10x60
2	2.375	300	1327	0-0.06	3.46	4.80	1.85	3/8x2-3/8
65	73	20	8.66	0-1.6	100	137	47	M10x70
21/2	2.875	300	1945	0-0.06	3.94	5.39	1.85	3/8x2-3/4
65	76.1	20	9.41	0-1.6	100	137	47	M10x70
21/2	3	300	2114	0-0.06	3.94	5.39	1.85	3/8x2-3/4
80	88.9	20	12.84	0-1.6	116	154	47	M10x70
3	3.5	300	2885	0-1.7	4.57	6.06	1.85	3/8x2-3/4
100	114.3	20	21.22	0-4.1	142	188	52	M12x75
4	4.5	300	4769	0-0.16	5.59	7.40	2.05	1/2x3
125	139.7	20	31.70	0-4.1	170	219	52	M12x80
5	5.5	300	7124	0-0.16	6.69	8.62	2.05	1/2x3-1/8
125	141.3	20	32.43	0-4.1	170	219	52	M12x80
5	5.563	300	7288	0-0.16	6.69	8.62	2.05	1/2x3-1/8
150	159	20	41.06	0-4.1	196	244	52	M12x80
6	6.25	300	9229	0-0.16	7.72	9.61	2.05	1/2x3-1/8
150	165.1	20	44.27	0-4.1	197	244	52	M12x80
6	6.5	300	9950	0-0.16	7.76	9.61	2.05	1/2x3-1/8
150	168.3	20	46.00	0-4.1	199	246	52	M12x80
6	6.625	300	10340	0-0.16	7.83	9.69	2.05	1/2x3-1/8
200	219.1	20	77.97	0-4.1	262	322	66	M16x120
8	8.625	300	17524	0-0.16	10.31	12.68	2.60	5/8x4-3/4
250	273	20	121.05	0-4.1	325	400	66	M20x170
10	10.75	300	27206	0-0.16	12.80	15.75	2.60	3/4x6-7/10
300	323.9	20	170.39	0-4.1	376	468	67	M22x190
12	12.75	300	38297	0-0.16	14.80	18.43	2.64	7/8x7-1/4
350	355.6	20	198.53	0-4.1	410	500	75	M22x190
14	14	300	46150	0-0.16	16.14	19.69	2.95	7/8x7-1/2
400	406.4	20	259.30	0-4.1	459	550	75	M22x190
16	16	300	60280	0-0.16	18.07	21.65	2.95	7/8x7-1/2

MODEL XGQT1 RIGID COUPLING

- T & G Design -

The Model XGQT1 is a T&G (tongue & groove) design rigid coupling for moderate pressure applications where rigidity is required including valve connections, mechanical rooms, fire mains and long straight runs. The built-in teeth and T&G mechanism firmly grasp the pipe ends to eliminate undesired. Support and hanging requirements correspond to ANSI B31.1, B31.9 and NFPA 13.

Sizes available: 32mm-300mm / 1-1/4"~12"

Working Pressure: Up to 20 bar / 300 psi

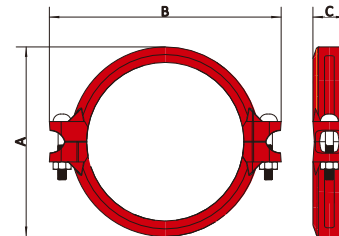

Nominal Size mm/in	Pipe O.D. mm/in	Max.Working Pressure Bar/PSI	Max.End Load KN/Lbs	Axial Displacement mm/in	Dimensions			Bolts Size mm/in
					A mm/in	B mm/in	C mm/in	
25	33.7	20	1.80	0-1.6	55	97	45	M10x40
1	1.327	300	405	0-0.06	2.17	3.82	1.77	3/8x1-1/2
32	42.4	20	2.92	0-1.6	63.5	107.5	45	M10x45
11/4	1.669	300	656	0-0.06	2.50	4.23	1.77	3/8x1-3/4
40	48.3	20	3.79	0-1.6	69	114	45	M10x45
11/2	1.9	300	852	0-0.06	2.72	4.49	1.77	3/8x1-3/4
50	60.3	20	5.91	0-1.6	83.6	124	46	M10x55
2	2.375	300	1327	0-0.06	3.29	4.88	1.81	3/8x2-1/8
65	73	20	8.66	0-1.6	98	137	46	M10x55
21/2	2.875	300	1945	0-0.06	3.86	5.39	1.81	3/8x2-1/8
65	76.1	20	9.41	0-1.6	98	139	46	M10x55
21/2	3	300	2114	0-0.06	3.86	5.47	1.81	3/8x2-1/8
80	88.9	20	12.84	0-1.6	114	156	46	M10x55
3	3.5	300	2885	0-0.06	4.49	6.14	1.81	3/8x2-1/8
100	108	20	18.94	0-4.1	138	186	50	M12x65
4	4.25	300	4258	0-0.16	5.43	7.32	1.97	1/2x2-5/8
100	114.3	20	21.22	0-4.1	142	189	50	M12x65
4	4.5	300	4769	0-0.16	5.59	7.44	1.97	1/2x2-5/8
125	133	20	28.73	0-4.1	164	213	50	M12x65
5	5.25	300	6457	0-0.16	6.46	8.39	1.97	1/2x2-5/8
125	139.7	20	31.70	0-4.1	170	222	50	M12x65
5	5.5	300	7124	0-0.16	6.69	8.74	1.97	1/2x2-5/8
125	141.3	20	32.43	0-4.1	170	218	50	M12x65
5	5.563	300	7288	0-0.16	6.69	8.58	1.97	1/2x2-5/8
150	159	20	41.06	0-4.1	192	244	50	M12x65
6	6.25	300	9229	0-0.16	7.56	9.61	1.97	1/2x2-5/8
150	165.1	20	44.27	0-4.1	196	244	50	M12x65
6	6.5	300	9950	0-0.16	7.72	9.61	1.97	1/2x2-5/8
150	168.3	20	46.00	0-4.1	198	251	50	M12x65
6	6.625	300	10340	0-0.16	7.80	9.88	1.97	1/2x2-5/8
200	216.3	20	75.99	0-4.1	254	340	62	M20x90
8	8.515	300	17079	0-0.16	10.00	13.39	2.44	3/4x3-1/2
200	219.1	20	77.97	0-4.1	256	316	60	M16x80
8	8.625	300	17524	0-0.16	10.08	12.44	2.36	5/8x3-1/8
250	267.4	20	116.13	0-4.1	313	400	64	M20x90
10	10.527	300	26101	0-0.16	12.32	15.75	2.52	3/4x3-1/2
250	273	20	121.05	0-4.1	319	393	64	M20x90
10	10.75	300	27206	0-0.16	12.56	15.47	2.52	3/4x3-1/2
300	318.5	20	164.76	0-4.1	368	464	64	M22x110
12	12.539	300	37031	0-0.16	14.49	18.27	2.52	7/8x4-1/3
300	323.9	20	170.39	0-4.1	374	453	65	M20x110
12	12.75	300	38297	0-0.16	14.72	17.83	2.56	3/4x4-1/3

MODEL XGQT4 PUSH-ON COUPLING

- patent pending -

The Model XGQT4 PUSH-ON rigid coupling is a truly rigid grooved pipe coupling which, unlike other grooved couplings, does not allow for any axial movement, angular movement and or rotational movement under normal service conditions. Lede push-on coupling (patent pending) allows the pipe to move into the couplings directly without loosening components. Support and hanging requirements correspond to ANSI B31.1, B31.9 and NFPA 13.

Caution: Pipe ends must be cut square so that the pipe ends butt together.

Applications:

- All piping including mechanical rooms where no angular or axial movement is desired
- Dry-system fire protection pipelines
- Stainless steel piping for potable water and food industries (epoxy coated housings with NSF61 certified gasket and type 316 bolts and silicone bronze nuts)
- Hot water systems

Sizes available: 32mm-200mm / 1-1/4"~8"

Working Pressure: Up to 20 bar / 300 psi

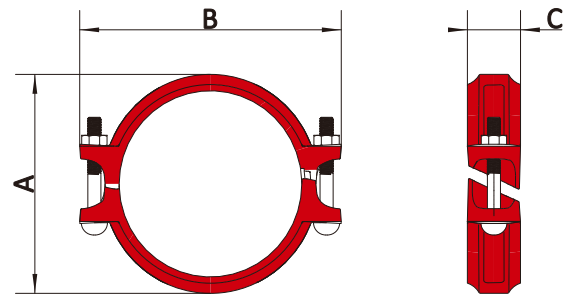

Nominal Size mm/in	Pipe O.D. mm/in	Max.Working Pressure Bar/PSI	Max.End Load KN/Lbs	Axial Displacement	Dimensions			Bolts Size mm/in
					mm/in	mm/in	mm/in	
32	42.4	20	2.92	0-1.6	71.5	112	47	M10×60
11/4	1.669	300	656	0-0.06	2.81	4.41	1.85	3/8×60
40	48.3	20	3.79	0-1.6	78	117	47	M10×60
11/2	1.9	300	852	0-0.06	3.07	4.61	1.85	3/8×60
50	60.3	20	5.91	0-1.6	90	132	48	M10×60
2	2.375	300	1327	0-0.06	3.54	5.20	1.89	3/8×60
65	76.1	20	9.41	0-1.6	106	150	48	M10×70
21/2	3	300	2114	0-0.06	4.17	5.91	1.89	3/8×70
80	88.9	20	12.84	0-1.6	121	164	49	M12×75
3	3.5	300	2885	0-1.7	4.76	6.46	1.93	1/2×75
100	114.3	20	21.22	0-4.1	147	190	52	M12×75
4	4.5	300	4769	0-0.16	5.79	7.48	2.05	1/2×75
125	139.7	20	31.70	0-4.1	174	222	52	M12×80
5	5.5	300	7124	0-0.16	6.85	8.74	2.05	1/2×80
150	165.1	20	44.27	0-4.1	204	263	52	M16×85
6	6.5	300	9950	0-0.16	8.03	10.35	2.05	5/8×3-1/3
150	168.3	20	46.00	0-4.1	206	264	52	M16×85
6	6.625	300	10340	0-0.16	8.11	10.39	2.05	5/8×3-1/3
200	219.1	20	77.97	0-4.1	320	252	65	M16×120
8	8.625	300	17524	0-0.16	12.60	9.92	2.56	5/8×4-3/4

MODEL 31HP EXTRA HEAVY RIGID COUPLING

The Model 31HP is an extra heavy rigid coupling designed for high pressure services up to 1000 psi (70 bar). The wider housing keys grip the grooved with the aid of heavy duty bolts and nuts. The bolts and nuts must be tightened to the required torque to achieve rigidity.

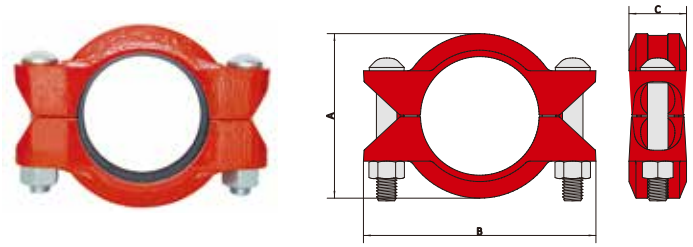

Nominal Size mm/in	Pipe O.D. mm/in	Max.Working Pressure Bar/PSI	Max.End Load KN/Lbs	Axial Displacement mm/in	Dimensions			Bolts	
					A mm/in	B mm/in	C mm/in	No.	Size mm/in
50	60.3	70	19.98	0-3.6	90	145	49	2	M16x80
2	2.375	1000	4420	0.014	3.54	5.71	1.93	2	5/8x3-1/8
65	73	70	29.28	0-3.6	102	168	49	2	M16x80
2 1/2	2.875	1000	6480	0.014	4.02	6.61	1.93	2	5/8x3-1/8
80	88.9	70	43.43	0-3.6	123	188	49	2	M16x80
3	3.5	1000	9610	0.014	4.84	7.40	1.93	2	5/8x3-1/8
100	114.3	70	71.79	0-6.4	153	216	54	2	M20x110
4	4.5	1000	15890	0-0.25	6.02	8.50	2.13	2	3/4x4-1/3
150	168.3	70	155.65	0-6.4	218	295	57	2	M22x130
6	6.625	1000	34450	0-0.25	8.58	11.61	2.24	2	7/8x5-1/8
200	219.1	55	207.26	0-6.4	275	364	70	2	M24x90
8	8.625	800	46710	0-0.25	10.83	14.33	2.76	2	1x3-1/2
250	273	55	321.78	0-6.4	334	424	75	2	M24x90
10	10.75	800	72570	0-0.25	13.15	16.69	2.95	2	1x3-1/2
300	323.9	55	452.95	0-6.4	390	480	75	2	M24x90
12	12.75	800	102080	0-0.25	15.35	18.90	2.95	2	1x3-1/2

MODEL XGQT2 LIGHT FLEXIBLE COUPLING

The Model XGQT2 is a standard flexible coupling for use in a variety of general piping applications of moderate pressure services. The Model XGQT2 couplings features flexibility that can deal with misalignment, distortion, thermal stress, vibration and noise and also resist seismic tremors. With the use of Model XGQT2 couplings you can even design a curved layout.



Sizes available: 25mm-600mm / 1"~24"

Working Pressure: Up to 20 bar / 300 psi

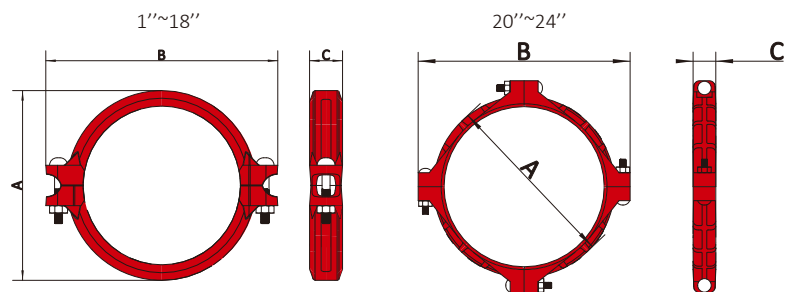

GROOVED COUPLINGS

Nominal Size mm/in	Actual O.D. mm/in	Max. Working Pressure Bar/PSI	Max. End Load KN/Lbs	Axial Displacement mm/in	Angular Movement		Dimensions			Bolt
					Per Coupling Degree (°)	Per Pipe in/ft	A mm/in	B mm/in	C mm/in	Size mm/in
25	33.7	20	1.80	1.6	2°-45'	0.58	55	97	45	M10×40
1	1.327	300	405	0.0625		48	2.17	3.82	1.77	3/8×1-1/2
32	42.4	20	2.92	1.6	2°-10'	0.46	63.5	107.5	45	M10×45
11/4	1.669	300	656	0.0625		38	2.50	4.23	1.77	3/8×1-3/4
40	48.3	20	3.79	1.6	1°-54'	0.4	69	114	45	M10×45
11/2	1.9	300	852	0.0625		33	2.72	4.49	1.77	3/8×1-3/4
50	60.3	20	5.91	1.6	1°-31'	0.32	83.6	124	46	M10×55
2	2.375	300	1327	0.0625		27	3.29	4.88	1.81	3/8×2-1/8
65	73	20	8.66	1.6	1°-15'	0.26	98	137	46	M10×55
21/2	2.875	300	1945	0.0625		22	3.86	5.39	1.81	3/8×2-1/8
65	76.1	20	9.41	1.6	1°-12'	0.25	98	139	46	M10×55
21/2	3	300	2114	0.0625		21	3.86	5.47	1.81	3/8×2-1/8
80	88.9	20	12.84	1.6	1°-02'	0.22	114	156	46	M10×55
3	3.5	300	2885	0.0625		18	4.49	6.14	1.81	3/8×2-1/8
100	108	20	18.94	3.2	1°-42'	0.36	138	186	50	M12×65
4	4.25	300	4258	0.125		30	5.43	7.32	1.97	1/2×2-5/8
100	114.3	20	21.22	3.2	1°-36'	0.34	142	189	50	M12×65
4	4.5	300	4769	0.125		28	5.59	7.44	1.97	1/2×2-5/8
125	133	20	28.73	3.2	1°-23'	0.29	164	213	50	M12×65
5	5.25	300	6457	0.125		24	6.46	8.39	1.97	1/2×2-5/8
125	139.7	20	31.70	3.2	1°-18'	0.27	170	222	50	M12×65
5	5.5	300	7124	0.125		23	6.69	8.74	1.97	1/2×2-5/8
125	141.3	20	32.43	3.2	1°-18'	0.27	170	218	50	M12×65
5	5.563	300	7288	0.125		23	6.69	8.58	1.97	1/2×2-5/8
150	159	20	41.06	3.2	1°-09'	0.24	192	244	50	M12×65
6	6.25	300	9229	0.125		20	7.56	9.61	1.97	1/2×2-5/8
150	165.1	20	44.27	3.2	1°-07'	0.24	196	244	50	M12×65
6	6.5	300	9950	0.125		20	7.72	9.61	1.97	1/2×2-5/8
150	168.3	20	46.00	3.2	1°-05'	0.23	198	251	50	M12×65
6	6.625	300	10340	0.125		19	7.80	9.88	1.97	1/2×2-5/8
200	216.3	20	75.99	3.2	0°-50'	0.18	254	340	62	M20×90
8	8.515	300	17079	0.125		15	10.00	13.39	2.44	3/4×3-1/2
200	219.1	20	77.97	3.2	0°-50'	0.18	256	316	60	M16×80
8	8.625	300	17524	0.125		15	10.08	12.44	2.36	5/8×3-1/8
250	267.4	20	116.13	3.2	0°-50'	0.14	313	400	64	M20×90
10	10.527	300	26101	0.125		12	12.32	15.75	2.52	3/4×3-1/2
250	273.0	20	121.05	3.2	0°-50'	0.14	319	393	64	M20×90
10	10.75	300	27206	0.125		12	12.56	15.47	2.52	3/4×3-1/2
300	318.5	20	164.76	3.2	0°-50'	0.12	368	464	64	M22×110
12	12.539	300	37031	0.125		10	14.49	18.27	2.52	7/8×4-1/3
300	323.9	20	170.39	3.2	0°-50'	0.12	374	453	65	M20×110
12	12.75	300	38297	0.125		10	14.72	17.83	2.56	3/4×4-1/3
350	355.6	20	198.53	3.2	0°-31'	0.06	410	510	75	M22×110
14	14	300	46150	0.125		4.5	16.14	20.08	2.95	7/8×4-1/3
350	377	20	230.84	3.2	0°-29'	0.06	428	520	75	M22×140
14	14.843	300	51883	0.125		4.5	16.85	20.47	2.95	7/8×5-1/2
400	406.4	20	259.30	3.2	0°-27'	0.05	459	555	75	M22×140
16	16	300	60280	0.125		4	18.07	21.85	2.95	7/8×5-1/2
400	426	20	294.74	3.2	0°-25'	0.05	480	572	75	M22×140
16	16.771	300	66246	0.125		4	18.90	22.52	2.95	7/8×5-1/2
450	457.2	20	327.89	3.2	0°-24'	0.04	516	606	78	M22×140
18	18	300	76300	0.125		3.5	20.31	23.86	3.07	7/8×5-1/2
450	480.0	20	374.20	3.2	0°-22'	0.04	540	631	78	M22×160
18	18.9	300	84106	0.125		3	21.26	24.84	3.07	7/8×6-1/3
500	508.0	20	490.60	3.2	0°-19'	0.04	567	674	78	M22×140
20	20	300	113980	0.125		3	22.32	26.54	3.07	7/8×5-1/2
550	558.8	20	584.20	3.2	0°-18'	0.03	622	728	78	M22×140
22	22	300	135640	0.125		2.5	24.49	28.66	3.07	7/8×5-1/2
600	609.6	20	684.72	3.2	0°-17'	0.03	674	778	78	M24×150
24	24	300	159190	0.125		2.5	26.54	30.63	3.07	1×5-9/10

Deflection or angular movement is the maximum value that a coupling allows under no internal pressure.

MODEL 1212 HEAVY DUTY FLEXIBLE COUPLING

The Model 1212 heavy duty flexible coupling is designed for use in a variety of general piping applications of moderate or high pressure services. Working pressure is usually dictated by the wall thickness and rating of the pipe being used. The Model 1212 couplings feature flexibility that can deal with misalignment, distortion, thermal stress, vibration and noise and also resist seismic tremors. With the use of Model 1212 couplings you can even design a curved layout. See Typical Applications – Flexible Couplings on page 44.

Sizes available: 32mm-300mm / 1 1/4"~12"

Working Pressure: Up to 35 bar / 500 psi

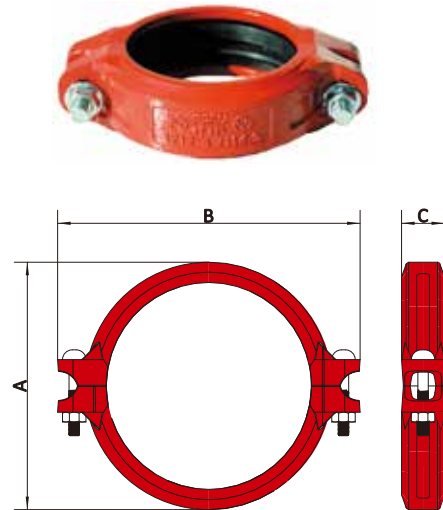

Nominal Size mm/in	Actual O.D. mm/in	Max. Working Pressure Bar/PSI	Max. End Load KN/Lbs	Axial Displacement mm/in	Angular Movement		Dimensions			Bolt	
					Per Coupling Degree (°)	Per Pipe in/ft	A mm/in	B mm/in	C mm/in	No.	Size mm/in
32 1 1/4	42.4 1.669	35 500	2.92 656	1.6 0.0625	2°-10'	0.46 38	63.5 2.50	107.5 4.23	45 1.77	2	M10x45 3/8x1-3/4
40 1 1/2	48.3 1.9	35 500	3.79 852	1.6 0.0625	1°-54'	0.4 33	69 2.72	114 4.49	45 1.77	2	M10x45 3/8x1-3/4
50 2	60.3 2.375	35 500	9.84 2212	1.6 0.0625	1°-31'	0.32 27	83 3.27	124 4.88	46 1.81	2	M10x55 3/8x2-1/8
65 2 1/2	73 2.875	35 500	14.64 3240	1.6 0.0625	1°-15'	0.26 22	100 3.94	145 5.71	47 1.85	2	M12x65 1/2x2-5/8
65 2 1/2	76.1 3	35 500	15.68 3523	1.6 0.0625	1°-12'	0.25 21	101.6 4.00	146 5.75	47 1.85	2	M12x65 1/2x2-5/8
80 3	88.9 3.5	35 500	21.39 4808	1.6 0.0625	1°-02'	0.22 18	116 4.57	162 6.38	47 1.85	2	M12x65 1/2x2-5/8
100 4	114.3 4.5	35 500	35.36 7948	3.2 0.125	1°-36'	0.34 28	144 5.67	194 7.64	51 2.01	2	M12x70 1/2x2-3/4
125 5	139.7 5.5	35 500	52.83 11874	3.2 0.125	1°-18'	0.28 23	171 6.73	230 9.06	52 2.05	2	M16x85 5/8x3-1/4
125 5	141.3 5.563	35 500	48.59 10930	3.2 0.125	1°-18'	0.28 23	171 6.73	230 9.06	52 2.05	2	M16x85 5/8x3-1/4
150 6	165.1 6.5	35 500	66.33 14920	3.2 0.125	1°-07'	0.24 20	198 7.80	260 10.24	53 2.09	2	M16x85 5/8x3-1/4
150 6	168.3 6.625	35 500	76.67 17233	3.2 0.125	1°-05'	0.24 20	200 7.87	261 10.28	53 2.09	2	M16x85 5/8x3-1/4
200 8	216.3 8.515	35 500	126.64 28465	3.2 0.125	0°-51'	0.18 15	265 10.43	336 13.23	63 2.48	2	M20x110 3/4x4-1/4
200 8	219.1 8.625	35 500	129.94 29206	3.2 0.125	0°-50'	0.18 15	263 10.35	336 13.23	63 2.48	2	M20x110 3/4x4-1/4
250 10	267.4 10.527	35 500	193.55 43502	3.2 0.125	0°-41'	0.15 12	317 12.48	403 15.87	66 2.60	2	M22x140 7/8x4-1/2
250 10	273 10.75	35 500	201.74 45344	3.2 0.125	0°-40'	0.15 12	326 12.83	410 16.14	66 2.60	2	M22x140 7/8x4-1/2
300 12	318.5 12.539	35 500	274.59 61718	3.2 0.125	0°-35'	0.12 10	375 14.76	463 18.23	66 2.60	2	M22x140 7/8x4-1/2
300 12	323.9 12.75	35 500	283.98 63828	3.2 0.125	0°-34'	0.12 10	381 15.00	469 18.46	66 2.60	2	M22x140 7/8x4-1/2

Deflection or angular movement is the maximum value that a coupling allows under no internal pressure.

MODEL XGQT3 REDUCING COUPLING

The Model XGQT3 reducing coupling allows for direct reduction on a piping run and eliminates the need for a concentric reducer and couplings. The specially designed rubber gasket helps prevent small pipe from telescoping into larger pipe during vertical assembly.

Caution: The Model XGQT3 couplings should not be used with an end cap, as the end may be sucked into the pipe when draining the system.

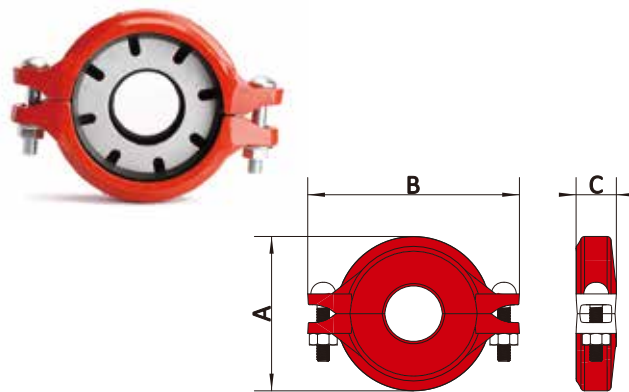

Nominal Size mm/in	Actual O.D. mm/in	Max. Working Pressure Bar/PSI	Max. End Load KN/Lbs	Axial Displacement mm/in	Deflection		Dimensions			Bolt Size mm/in
					Degree Per Coupling(°)	Pipe mm/m in/ft	A mm/in	B mm/in	C mm/in	
40x32	48.3x42.4	20	3.79	1.6		0.4	70	113	45	M10x50
11/2x11/4	1.9x1.669	300	852	0.0625	1°-54'	33	2.76	4.45	1.77	3/8x2
50x40	60.3x48.3	20	5.91	1.6	1°-31'	0.32	82	130	46	M10x55
2x11/2	2.375x1.9	300	1327	0.0625		27	3.23	5.12	1.81	3/8x2-1/8
65x25	73x33.7	20	8.66	1.6	1°-15'	0.26	97	151	46	M10x55
21/2x1	2.875x1.327	300	1945	0.0625		22	3.82	5.94	1.81	3/8x2-1/8
65x32	73x42.4	20	8.66	1.6	1°-15'	0.26	97	151	46	M10x55
21/2x11/4	2.875x1.669	300	1945	0.0625		22	3.82	5.94	1.81	3/8x2-1/8
65x40	73x48.3	20	8.66	1.6	1°-15'	0.26	97	151	46	M10x55
21/2x11/2	2.875x1.9	300	1945	0.0625		22	3.82	5.94	1.81	3/8x2-1/8
65x50	73x60.3	20	8.66	1.6	1°-15'	0.26	97	151	46	M10x55
21/2x2	2.875x2.375	300	1945	0.0625		22	3.82	5.94	1.81	3/8x2-1/8
65x50	76.1x60.3	20	9.41	1.6	1°-12'	0.25	97	151	46	M10x55
21/2x2	3x2.375	300	2114	0.0625		21	3.82	5.94	1.81	3/8x2-1/8
65x65	76.1x73	20	9.41	1.6	1°-12'	0.25	97	151	46	M10x55
21/2x21/2	3x2.875	300	2114	0.0625		21	3.82	5.94	1.81	3/8x2-1/8
80x40	88.9x48.3	20	12.84	1.6	1°-02'	0.22	112	166.6	46	M12x65
3x11/2	3.5x1.9	300	2885	0.0625		18	4.41	6.56	1.81	1/2x2-5/8
80x50	88.9x60.3	20	12.84	1.6	1°-02'	0.22	112	166.6	46	M12x65
3x2	3.5x2.375	300	2885	0.0625		18	4.41	6.56	1.81	1/2x2-5/8
80x65	88.9x73.0	20	12.84	1.6	1°-02'	0.22	112	166.6	46	M12x65
3x21/2	3.5x2.875	300	2885	0.0625		18	4.41	6.56	1.81	1/2x2-5/8
80x65	88.9x76.1	20	12.84	1.6	1°-02'	0.22	114	166.6	46	M12x65
3x21/2	3.5x3	300	2885	0.0625		18	4.49	6.56	1.81	1/2x2-5/8
100x50	114.3x60.3	20	21.22	3.2	1°-36'	0.34	141	200	50	M12x65
4x2	4.5x2.375	300	4769	0.125		28	5.55	7.87	1.97	1/2x2-5/8
100x65	114.3x73.0	20	21.22	3.2	1°-36'	0.34	141	200	50	M12x65
4x21/2	4.5x2.875	300	4769	0.125		28	5.55	7.87	1.97	1/2x2-5/8
100x65	114.3x76.1	20	21.22	3.2	1°-36'	0.34	151.2	200	50	M12x65
4x21/2	4.5x3.0	300	4769	0.125		28	5.95	7.87	1.97	1/2x2-5/8
100x80	114.3x88.9	20	21.22	3.2	1°-36'	0.34	141.8	200	50	M12x65
4x3	4.5x3.5	300	4769	0.125		28	5.58	7.87	1.97	1/2x2-5/8
125x100	139.7x114.3	20	31.70	3.2	1°-18'	0.27	169	235	52	M16x80
5x4	5.5x4.5	300	7124	0.125		23	6.65	9.25	2.05	5/8x3-1/8
125x100	141.3x114.3	20	32.43	3.2	1°-18'	0.27	167	230	52	M16x80
5x4	5.563x4.5	300	7288	0.125		23	6.57	9.06	2.05	5/8x3-1/8
150x80	165.1x88.9	20	44.27	3.2	1°-07'	0.24	197	275	52	M16x80
6x3	6.5x3.5	300	9950	0.125		20	7.76	10.83	2.05	5/8x3-1/8
150x100	165.1x114.3	20	44.27	3.2	1°-07'	0.24	197	275	52	M16x80
6x4	6.5x4.5	300	9950	0.125		20	7.76	10.83	2.05	5/8x3-1/8
150x65	168.3x73	20	46.00	3.2	1°-06'	0.23	199.4	275	52	M16x80
6x21/2	6.525x2.875	300	10340	0.125		19	7.85	10.83	2.05	5/8x3-1/8
150x80	168.3x88.9	20	46.00	3.2	1°-06'	0.23	199.4	275	52	M16x80
6x3	6.525x3.5	300	10340	0.125		19	7.85	10.83	2.05	5/8x3-1/8
150x100	168.3x114.3	20	46.00	3.2	1°-06'	0.23	199.4	275	52	M16x80
6x4	6.525x4.5	300	10340	0.125		19	7.85	10.83	2.05	5/8x3-1/8
150x100	168.3x141.3	20	46.00	3.2	1°-06'	0.23	199.4	275	52	M16x80
6x5	6.625x5.563	300	10340	0.125		19	7.85	10.83	2.05	5/8x3-1/8
150x150	168.3x165.1	20	46.00	3.2	1°-06'	0.23	199.4	275	52	M16x80
6x6	6.625x6.5	300	10340	0.125		19	7.85	10.83	2.05	5/8x3-1/8
200x100	219.1x114.3	20	77.97	3.2	0°-50'	0.18	256	336	58	M20x110
8x4	8.625x4.5	300	17524	0.125		15	10.08	13.23	2.28	3/4x4-1/3
200x150	219.1x168.3	20	77.97	3.2	0°-50'	0.18	256	336	58	M20x110
8x6	8.625x6.525	300	17524	0.125		15	10.08	13.23	2.28	3/4x4-1/3

Deflection or angular movement is the maximum value that a coupling allows under no internal pressure.

MODEL L991 FLANGE ANSI CLASS 125/150

The Model L991 Flange allows for direct connection of grooved system to ANSI class 125/150 flanged components.

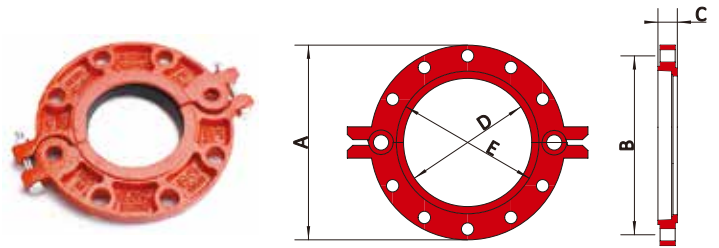

Nominal Size mm/in	Pipe O.D. mm/in	Max. Working Pressure Bar/PSI	Max. End Load KN/Lbs	Dimensions					Bolt	
				A mm/in	B mm/in	C mm/in	D mm/in	E mm/in	No.	Size mm/in
50	60.3	17	5.71	155	120.5	25	60	78	4	M16
2	2.375	250	1330	6.10	4.74	0.98	2.36	3.07	4	5/8
65	73.0	17	8.37	180	140	25	73	93	4	M16
2.5	2.875	250	1950	7.09	5.51	0.98	2.87	3.66	4	5/8
80	88.9	17	12.41	190	153	25	89	107	4	M16
3	3.500	250	2880	7.48	6.02	0.98	3.50	4.21	4	5/8
100	114.3	17	20.51	230	191	25	114	131	8	M16
4	4.500	250	4770	9.06	7.52	0.98	4.49	5.16	8	5/8
125	141.3	17	31.35	255	216	25	141	157	8	M20
5	5.563	250	7290	10.04	8.50	0.98	5.55	6.18	8	3/4
150	168.3	17	44.47	280	241	25	168	185	8	M20
6	6.625	250	10340	11.02	9.49	0.98	6.61	7.28	8	3/4
200	219.1	17	75.37	345	299	27	219	234	8	M20
8	8.625	250	17520	13.58	11.77	1.06	8.62	9.21	8	3/4
250	273.0	17	164.71	405	362	30	273	294	12	M24
10	10.750	250	27210	15.94	14.25	1.18	10.75	11.57	12	1
300	323.9	17	164.71	485	432	32	324	341	12	M24
12	12.75	250	38280	19.09	17.01	1.26	12.76	13.43	12	1

MODEL XGQT09 FLANGE – PN10/PN16

The Model XGQT09 Flange allows for a direct connection with PN10/PN16 flanges. The unique shaped gasket allows for the transition from a flanged system to a grooved system to a grooved system with a single flange.

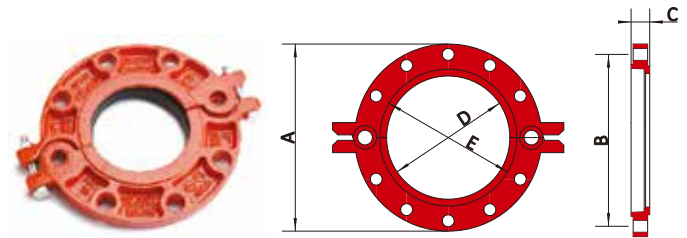

Nominal Size mm/in	Pipe O.D. mm/in	Max. Working Pressure Bar/PSI	Max. End Load KN/Lbs	Dimensions			Sealing Surface		Bolt	
				A mm	B mm	C mm	D mm	E mm	No.	Size mm
50	60.3	16	4.60	164	125	25	60	78	4	M16
2	2.375	225	1000	164	125	25	60	78	4	M16
65	73	16	6.64	182	145	25	73	93	8	M16
2 1/2	2.875	225	1491	182	145	25	73	93	8	M16
65	76.1	16	7.30	182	145	25	76	93	8	M16
2 1/2	3	225	1590	182	145	25	76	93	8	M16
80	88.9	16	9.90	194	160	25	89	107	8	M16
3	3.5	225	2165	194	160	25	89	107	8	M16
100	108	16	14.52	216	180	25	108	130	8	M16
4	4.25	225	3264	216	180	25	108	130	8	M16
100	114.3	16	16.40	216	180	25	114	131	8	M16
4	4.5	225	3580	216	180	25	114	131	8	M16
125	133	16	22.03	247	210	25	133	156	8	M16
5	5.25	225	4951	247	210	25	133	156	8	M16
125	139.7	16	24.50	247	210	25	140	157	8	M16
5	5.5	225	5340	247	210	25	140	157	8	M16
125	141.3	16	24.86	247	210	25	141	157	8	M16
5	5.563	225	5588	247	210	25	141	157	8	M16
150	159	16	31.48	282	240	25	159	184	8	M20
6	6.25	225	7075	282	240	25	159	184	8	M20
150	165.1	16	34.20	282	240	25	165	185	8	M20
6	6.5	225	7460	282	240	25	165	185	8	M20
150	168.3	16	35.60	282	240	25	168	185	8	M20
6	6.625	225	7750	282	240	25	168	185	8	M20
200	219.1	16	60.30	335	295	27	219	234	12	M20
8	8.625	225	13140	335	295	27	219	234	12	M20

Note: 2" - 6" flange drilling to PN10 / PN16 and 8" and above to PN16.

MODEL L981 FLANGE ADAPTER CLASS 125/150

The Model L981 Universal Flange Adapter provides a rigid transition from a flanged component to a grooved system.

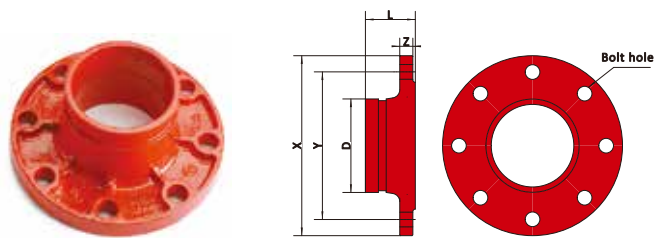

Nominal Size mm/in	Pipe O.D. mm/in	Max.Working Pressure Bar/PSI	X mm/in	Y mm/in	Z mm/in	L mm/in	Bolts Size mm/in	Bolts No.
50	60.3	20	155	120.5	16	65	M16	4
2	2.375	300	6.10	4.74	0.63	2.56	5/8	4
65	73.00	20	180	140	16	65	M16	4
21/2	2.875	300	7.09	5.51	0.63	2.56	5/8	4
80	88.90	20	190	153	18	65	M16	4
3	3.50	300	7.48	6.02	0.71	2.56	5/8	4
100	114.30	20	230	191	22	70	M16	8
4	4.50	300	9.06	7.52	0.87	2.76	5/8	8
125	141.3	20	255	216	22	70	M20	8
5	5.563	300	10.04	8.50	0.87	2.76	3/4	8
150	168.30	20	280	241	22	70	M20	8
6	6.625	300	11.02	9.49	0.87	2.76	3/4	8
200	219.1	20	345	299	25	80	M20	8
8	8.625	300	13.58	11.77	0.98	3.15	3/4	8
250	273	20	405	362	26	85	M24	12
10	10.75	300	15.94	14.25	1.02	3.35	1	12
300	323.9	20	485	432	28	90	M24	12
12	12.75	300	19.09	17.01	1.10	3.54	1	12

MODEL XGQT08 FLANGE ADAPTER PN10/16

The Model XGQT08 Flange Adapter provides for a rigid transition between a flanged piping system and grooved system.

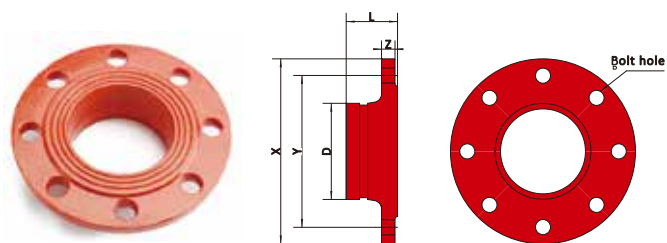

Nominal Size mm/in	Pipe O.D. mm/in	Max.Working Pressure Bar/PSI	X mm	Y mm	Z mm	L mm	Bolts Size mm/in	Bolts No.
50	60.30	15	165	125	15	60	M16	4
2	2.38	230	6.50	4.92	0.59	2.36	5/8	4
65	73.00	15	185	145	15	60	M16	4
21/2	2.88	230	7.28	5.71	0.59	2.36	5/8	4
65	76.10	15	185	145	15	60	M16	4
21/2	3.00	230	7.62	5.71	0.59	2.36	5/8	4
80	88.90	15	200	160	16	60	M16	8
3	3.50	230	8.27	6.35	0.63	2.36	5/8	8
100	108.00	15	220	180	16	60	M16	8
4	4.25	230	8.89	7.09	0.63	2.36	5/8	8
100	114.30	15	220	180	16	60	M16	8
4	4.50	230	9.14	7.09	0.63	2.36	5/8	8
125	133.00	15	250	210	18	65	M16	8
5	5.25	230	9.76	8.27	0.71	2.56	5/8	8
125	139.70	15	250	210	18	65	M16	8
5	5.50	230	9.91	8.27	0.71	2.56	5/8	8
125	141.30	15	250	210	18	65	M16	8
5	5.56	230	9.91	8.27	0.71	2.56	5/8	8
150	159.00	15	285	240	18	65	M20	8
6	6.25	230	10.57	9.45	0.71	2.56	5/8	8
150	165.10	15	285	240	18	65	M20	8
6	6.50	230	10.82	9.45	0.71	2.56	5/8	8
150	168.30	15	285	240	18	65	M20	8
6	6.63	230	10.94	9.45	0.71	2.56	5/8	8
200	219.10	15	340	295	19	70	M20	12
8	8.63	230	11.57	11.77	0.75	2.95	3/4	12
250	273.00	15	405	355	25	85	M24	12
10	10.75	230	13.58	14.25	1.02	3.35	1	12
300	323.90	15	460	410	27	85	M24	12
12	12.75	230	15.59	17.01	1.10	3.54	1	12

GROOVED ELBOWS

- MODEL XGQT01L 90° ELBOW**
- MODEL XGQT011L 45° ELBOW**
- MODEL XGQT012 22-1/2° ELBOW**
- MODEL XGQT013 11-1/4° ELBOW**

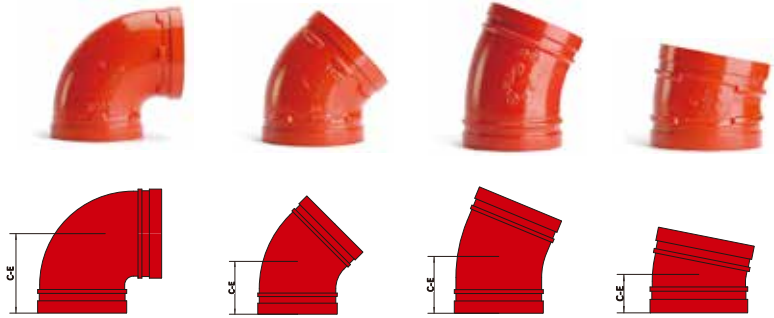

The grooved fittings are cast of ductile iron.

Nominal Size mm/in	Pipe O.D. mm/in	Max.Working Pressure Bar/PSI	XGQT01L 90° Elbow Standard	XGQT011L 45° Elbow Standard	XGQT012 22-1/2° Elbow	XGQT013 11-1/4° Elbow
			C- E	C- E	C- E	C- E
25	33.7	20	57	45	45	35
1	1.327	300	2.24	1.77	1.77	1.38
32	42.4	20	70	45	45	35
11/4	1.669	300	2.76	1.77	1.77	1.38
40	48.3	20	70	45	48	35
11/2	1.9	300	2.76	1.77	1.89	1.38
50	60.3	20	83	51	51	38
2	2.375	300	3.27	2.01	2.01	1.50
65	73	20	95	62	51	38
21/2	2.875	300	3.74	2.44	2.01	1.50
65	76.1	20	95	62	57	38
21/2	3	300	3.74	2.44	2.24	1.50
80	88.9	20	108	70	73	45
3	3.5	300	4.25	2.76	2.87	1.77
100	108	20	127	76	73	45
4	4.25	300	5	2.99	2.87	1.77
100	114.3	20	127	76	73	51
4	4.5	300	5	2.99	2.87	2.01
125	133	20	140	83	73	51
5	5.25	300	5.51	3.27	2.87	2.01
125	139.7	20	140	83	73	51
5	5.5	300	5.51	3.27	2.87	2.01
125	141.3	20	140	83	79	51
5	5.563	300	5.51	3.27	3.11	2.01
150	159	20	165	89	79	51
6	6.25	300	6.5	3.50	3.11	2.01
150	165.1	20	165	89	79	51
6	6.5	300	6.5	3.50	3.11	2.01
150	168.3	20	165	89	98	51
6	6.625	300	6.5	3.50	3.86	2.01
200	219.1	20	197	108	111	54
8	8.625	300	7.76	4.25	4.37	2.13
250	273	20	229	121	124	57
10	10.75	300	9.02	4.76	4.88	2.24
300	323.9	20	254	---	---	---
12	12.75	300	10	---	---	---

MODEL 2601 DRAIN ELBOW

The Model 2601 is a grooved-end ductile iron cast elbow with an integral 1" NPT or BSP drain. The 2601 was primarily designed for, but not limited to, used on fire protection standpipes.

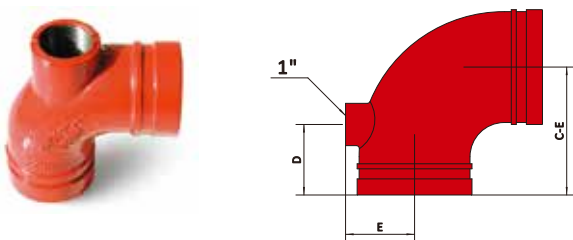

Nominal Size mm/in	Pipe O.D. mm/in	Max.Working Pressure Bar/PSI	Dimensions		
			C- E mm/in	D mm/in	E mm/in
50	60.3	20	83	70	37.5
2	2.375	300	3.27	2.76	1.48
65	73	20	95	70	45
21/2	2.875	300	3.74	2.76	1.77
80	88.9	20	108	70	55
3	3.5	300	4.25	2.76	2.17
100	114.3	20	127	70	68.5
4	4.5	300	5.00	2.76	2.70
125	141.3	20	140	70	82
5	5.563	300	5.51	2.76	3.23
150	168.3	20	165	70	95.5
6	6.625	300	6.50	2.76	3.76

MODEL XGQT01 SHORT RADIUS 90° ELBOW
MODEL XGQT011 SHORT 45° ELBOW
MODEL XGQT03 SHORT RADIUS TEE

The short radius fittings, while primarily designed for fire protection applications, can also be used for general service requirements.

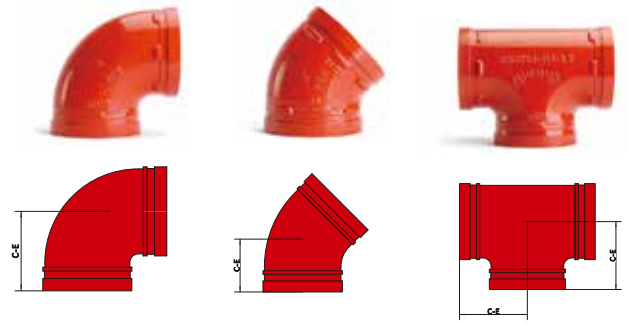

Nominal Size mm/in	Pipe O.D. mm/in	Max.Working Pressure Bar/PSI	XGQT01 SR 90° Elbow	XGQT011 45° Elbow	XGQT03 SR Straight Tee
			C- E (mm/in)	C- E (mm/in)	C- E (mm/in)
50	60.3	20	70	---	70
2	2.375	300	2.76	---	2.76
65	73	20	76	48	76
21/2	2.875	300	2.99	1.89	2.99
65	76.1	20	76	48	76
21/2	3	300	2.99	1.89	2.99
80	88.9	20	85	53	85
3	3.5	300	3.35	2.09	3.35
100	108	20	102	60	102
4	4.25	300	4.02	2.36	4.02
100	114.3	20	102	60	102
4	4.5	300	4.02	2.36	4.02
125	133	20	121	68	121
5	5.25	300	4.76	2.68	4.76
125	139.7	20	121	68	121
5	5.5	300	4.76	2.68	4.76
125	141.3	20	121	68	121
5	5.563	300	4.76	2.68	4.76
150	159	20	130	75.5	130
6	6.25	300	5.12	2.97	5.12
150	165.1	20	130	75.5	130
6	6.5	300	5.12	2.97	5.12
150	168.3	20	140	75.5	140
6	6.625	300	5.51	2.97	5.51
200	219.1	20	175	95	175
8	8.625	300	6.89	3.74	6.89
250	273	20	215	112	215
10	10.75	300	8.46	4.41	8.46
300	323.9	20	220	135	220
12	12.75	300	8.66	5.31	8.66

MODEL XGQT03 BULLHEAD TEE

The Model XGQT03 is a grooved-end bullhead tee, specially designed for use on fire protection systems allows you to directly split the flow into two reduced branch lines without the need for concentric reducers and multiple couplings.

Nominal Size mm/in	Pipe O.D. mm/in	Max.Working Pressure Bar/PSI	Dimensions	
			C- E mm/in	C1 - E1 mm/in
80×80×100 3×3×4	88.9×88.9×114.3 3.5×3.5×4.5	20 300	115 4.53	125 4.92
100×100×150 4×4×6	114.3×114.3×165.1 4.5×4.5×6.5	20 300	140 5.5	140 5.5

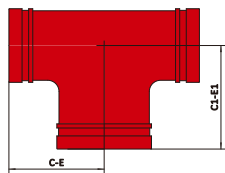

MODEL XGQT03L STANDARD TEE
MODEL XGQT05 SHORT RADIOUS CROSS
MODEL 5101 STANDARD CROSS
MODEL 450 45° LATERAL



The grooved fittings are cast of ductile iron.

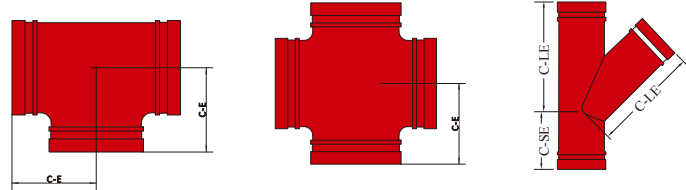

Nominal Size mm/in	Pipe O.D. mm/in	Max.Working Pressure Bar/PSI	XGQT03L Tee	XGQT05 Cross	5101 Cross	450 45° Lateral	
			C- E	C- E	C- E	C- LE	C- SE
25	33.7	20	57	---	57	---	---
1	1.327	300	2.24	---	2.24	---	---
32	42.4	20	70	---	70	---	---
11/4	1.669	300	2.76	---	2.76	---	---
40	48.3	20	70	---	70	---	---
11/2	1.9	300	2.76	---	2.76	---	---
50	60.3	20	84	70	84	178	70
2	2.375	300	3.31	2.76	3.31	7.00	2.75
65	73	20	95	76	95	197	76
21/2	2.875	300	3.74	2.99	3.74	7.75	3.00
65	76.1	20	95	76	95	197	76
21/2	3	300	3.74	2.99	3.74	7.75	3.00
80	88.9	20	108	86	108	216	83
3	3.5	300	4.25	3.39	4.25	8.50	3.25
100	108	20	127	102	127	---	---
4	4.25	300	5.00	4.02	5.00	---	---
100	114.3	20	127	102	127	267	95
4	4.5	300	5.00	4.02	5.00	10.50	3.75
125	133	20	140	121	140	318	102
5	5.25	300	5.51	4.76	5.51	12.50	4.00
125	139.7	20	140	121	140	318	102
5	5.5	300	5.51	4.76	5.51	12.50	4.00
125	141.3	20	140	121	140	---	---
5	5.563	300	5.51	4.76	5.51	---	---
150	159	20	165	130	165	---	---
6	6.25	300	6.50	5.12	6.50	---	---
150	165.1	20	165	130	165	356	114
6	6.5	300	6.50	5.12	6.50	14.00	4.50
150	168.3	20	165	140	165	---	---
6	6.625	300	6.50	5.51	6.50	---	---
200	219.1	20	197	174	197	457	152
8	8.625	300	7.76	6.85	7.76	18.00	6.00
250	273	20	229	215	229	521	165
10	10.75	300	9.02	8.46	9.02	20.50	6.50
300	323.9	20	254	245	254	584	178
12	12.75	300	10.00	9.65	10.00	23.00	7.00

MODEL XGQT03R3 GROOVED REDUCING TEE

The grooved reducing tees are cast of ductile iron.

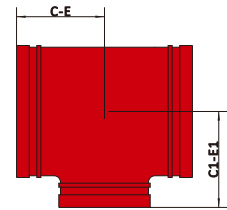

Nominal Size mm/in	Pipe O.D. mm/in	Max.Working Pressure Bar/PSI	Dimensions		Nominal Size mm/in	Pipe O.D. mm/in	Max.Working Pressure Bar/PSI	Dimensions	
			C-E mm/in	C1-E1 mm/in				C-E mm/in	C1-E1 mm/in
50x32	60.3x42.4	20	70	70	150x50	165.1x60.3	20	130	130
2x11/4	2.375x1.669	300	2.76	2.76	6x2	6.5x2.375	300	5.12	5.12
50x40	60.3x48.3	20	70	70	150x65	165.1x76.1	20	130	130
2x11/2	2.375x1.9	300	2.76	2.76	6x2 1/2	6.5x3	300	5.12	5.12
65x32	73x42.4	20	76	76	150x80	165.1x88.9	20	130	130
2 1/2x1 1/4	2.875x1.669	300	2.99	2.99	6x3	6.5x3.5	300	5.12	5.12
65x40	73x48.3	20	76	76	150x100	165.1x114.3	20	130	130
2 1/2x1 1/2	2.875x1.9	300	2.99	2.99	6x4	6.5x4.5	300	5.12	5.12
65x50	73x60.3	20	76	76	150x125	165.1x139.7	20	130	130
2 1/2x2	2.875x2.375	300	2.99	2.99	6x5	6.5x5.5	300	5.12	5.12
65x32	76.1x42.4	20	76	76	150x50	168.3x60.3	20	140	140
2 1/2x1 1/4	3x1.669	300	2.99	2.99	6x2	6.625x2.375	300	5.51	5.51
65x40	76.1x48.3	20	76	76	150x65	168.3x76.1	20	140	140
2 1/2x1 1/2	3x1.9	300	2.99	2.99	6x2 1/2	6.625x3	300	5.51	5.51
65x50	76.1x60.3	20	76	76	150x80	168.3x88.9	20	140	140
2 1/2x2	3x2.375	300	2.99	2.99	6x3	6.625x3.5	300	5.51	5.51
80x32	88.9x42.4	20	86	86	150x100	168.3x114.3	20	140	140
3x1 1/4	3.5x1.669	300	3.39	3.39	6x4	6.625x4.5	300	5.51	5.51
80x40	88.9x48.3	20	86	86	150x125	168.3x139.7	20	140	140
3x1 1/2	3.5x1.9	300	3.39	3.39	6x5	6.625x5.5	300	5.51	5.51
80x50	88.9x60.3	20	86	86	200x65	219.1x76.1	20	174	174
3x2	3.5x2.375	300	3.39	3.39	8x2 1/2	8.625x3	300	6.85	6.85
80x65	88.9x73	20	86	86	200x80	219.1x88.9	20	174	174
3x2 1/2	3.5x2.875	300	3.39	3.39	8x3	8.625x3.5	300	6.85	6.85
80x65	88.9x76.1	20	86	86	200x100	219.1x114.3	20	174	174
3x2 1/2	3.5x3	300	3.39	3.39	8x4	8.625x4.5	300	6.85	6.85
100x32	114.3x42.4	20	90	98*	00x125	219.1x139.7	20	174	174
4x1 1/4	4.5x1.669	300	3.54	3.86	8x5	8.625x5.5	300	6.85	6.85
100x40	114.3x48.3	20	90	98*	200x150	219.1x159	20	174	174
4x1 1/2	4.5x1.9	300	3.54	3.86	8x6	8.625x6.25	300	6.85	6.85
100x50	114.3x60.3	20	102	102	200x150	219.1x165.1	20	174	174
4x2	4.5x2.375	300	4.02	4.02	8x6	8.625x6.5	300	6.85	6.85
100x65	114.3x73	20	102	102	250x80	273x88.9	20	190	190
4x2 1/2	4.5x2.875	300	4.02	4.02	10x3	10.75x3.5	300	7.48	7.48
100x65	114.3x76.1	20	102	102	250x100	273x114.3	20	190	190
4x2 1/2	4.5x3	300	4.02	4.02	10x4	10.75x4.5	300	7.48	7.48
100x80	114.3x88.9	20	102	102	250x125	273x133	20	190	190
4x3	4.5x3.5	300	4.02	4.02	10x5	10.75x5.25	300	7.48	7.48
125x50	139.7x60.3	20	105	105	250x125	273x139.7	20	190	190
5x2	5.5x2.375	300	4.13	4.13	10x5	10.75x5.5	300	7.48	7.48
125x65	139.7x76.1	20	105	105	250x125	273x141.3	20	190	190
5x2 1/2	5.5x3	300	4.13	4.13	10x5	10.75x5.563	300	7.48	7.48
125x80	139.7x88.9	20	105	105	250x150	273x159	20	190	190
5x3	5.5x3.5	300	4.13	4.13	10x6	10.75x6.25	300	7.48	7.48
125x100	139.7x108	20	105	105	250x150	273x165.1	20	190	190
5x4	5.5x4.25	300	4.13	4.13	10x6	10.75x6.5	300	7.48	7.48
125x100	139.7x114.3	20	105	105	250x150	273x168.3	20	190	190
5x4	5.5x4.5	300	4.13	4.13	10x6	10.75x6.625	300	7.48	7.48
125x125	139.7x133	20	105	105	250x200	273x219.1	20	190	190
5x5	5.5x5.25	300	4.13	4.13	10x8	10.75x8.625	300	7.48	7.48
125x50	141.3x60.3	20	105	105	300x150	323.9x159	20	220	220
5x2	5.563x2.375	300	4.13	4.13	12x6	12.75x6.25	300	8.66	8.66
125x65	141.3x73	20	105	105	300x150	323.9x165.1	20	220	220
5x2 1/2	5.563x2.875	300	4.13	4.13	12x6	12.75x6.5	300	8.66	8.66
125x80	141.3x88.9	20	105	105	300x150	323.9x168.3	20	220	220
5x3	5.563x3.5	300	4.13	4.13	12x6	12.75x6.625	300	8.66	8.66
125x100	141.3x114.3	20	105	105	300x200	323.9x219.1	20	220	220
5x4	5.563x4.5	300	4.13	4.13	12x8	12.75x8.625	300	8.66	8.66
150x65	159x76.1	20	110	120*	300x250	323.9x273	20	220	220
6x2 1/2	6.25x3	300	4.33	4.72	12x10	12.75x10.75	300	8.66	8.66
150x80	159x88.9	20	110	120*					
6x3	6.25x3.5	300	4.33	4.72					

MODEL XGQT03S THREADED REDUCING TEE

The threaded reducing tees are cast of ductile iron.

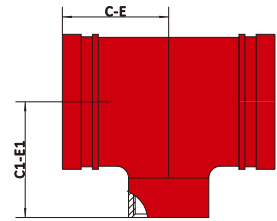

Nominal Size mm/in	Pipe O.D. mm/in	Max.Working Pressure Bar/PSI	Dimensions		Nominal Size mm/in	Pipe O.D. mm/in	Max.Working Pressure Bar/PSI	Dimensions	
			C-E mm/in	C1-E1 mm/in				C-E mm/in	C1-E1 mm/in
50x25	60.3x33.7	20	70	70	125x40	139.7x48.3	20	105	105
2x1	2.375x1.327	300	2.76	2.76	5x11/2	5.5x1.9	300	4.13	4.13
50x32	60.3x42.4	20	70	70	125x50	139.7x60.3	20	105	105
2x11/4	2.375x1.669	300	2.76	2.76	5x2	5.5x2.375	300	4.13	4.13
50x40	60.3x48.3	20	70	70	125x65	139.7x76.1	20	105	105
2x11/2	2.375x1.9	300	2.76	2.76	5x21/2	5.5x3	300	4.13	4.13
65x25	73.0x33.7	20	76	76	125x80	139.7x88.9	20	105	105
21/2x1	2.875x1.327	300	2.99	2.99	5x3	5.5x3.5	300	4.13	4.13
65x32	73.0x42.4	20	76	76	125x100	139.7x114.3	20	105	105
21/2x11/4	2.875x1.669	300	2.99	2.99	5x4	5.5x4.5	300	4.13	4.13
65x40	73.0x48.3	20	76	76	125x40	141.3x48.3	20	105	105
21/2x11/2	2.875x1.9	300	2.99	2.99	5x11/2	5.563x1.9	300	4.13	4.13
65x50	73.0x60.3	20	76	76	125x50	141.3x60.3	20	105	105
21/2x2	2.875x2.375	300	2.99	2.99	5x2	5.563x2.375	300	4.13	4.13
65x25	76.1x33.7	20	76	76	125x65	141.3x76.1	20	105	105
21/2x1	3x1.327	300	2.99	2.99	5x21/2	5.563x3	300	4.13	4.13
65x32	76.1x42.4	20	76	76	125x80	141.3x88.9	20	105	105
21/2x11/4	3x1.669	300	2.99	2.99	5x3	5.563x3.5	300	4.13	4.13
65x40	76.1x48.3	20	76	76	125x100	141.3x114.3	20	105	105
21/2x11/2	3x1.9	300	2.99	2.99	5x4	5.563x4.5	300	4.13	4.13
65x50	76.1x60.3	20	76	76	150x40	159.0x48.3	20	110	120*
21/2x2	3x2.375	300	2.99	2.99	6x11/2	6.25x1.9	300	4.33	4.72
80x25	88.9x33.7	20	86	86	150x50	159.0x60.3	20	110	120*
3x1	3.5x1.327	300	3.39	3.39	6x2	6.25x2.375	300	4.33	4.72
80x32	88.9x42.4	20	86	86	150x65	159.0x76.1	20	110	120*
3x11/4	3.5x1.669	300	3.39	3.39	6x21/2	6.25x3	300	4.33	4.72
80x40	88.9x48.3	20	86	86	150x80	159.0x88.9	20	110	120*
3x11/2	3.5x1.9	300	3.39	3.39	6x3	6.25x3.5	300	4.33	4.72
80x50	88.9x60.3	20	86	86	150x100	159.0x114.3	20	110	120*
3x2	3.5x2.375	300	3.39	3.39	6x4	6.25x4.5	300	4.33	4.72
80x65	88.9x76.1	20	86	86	150x40	165.1x48.3	20	110	120*
3x21/2	3.5x3	300	3.39	3.39	6x11/2	6.5x1.9	300	4.33	4.72
100x40	108.0x48.3	20	90	98*	150x50	165.1x60.3	20	110	120*
4x11/2	4.25x1.9	300	3.54	3.86	6x2	6.5x2.375	300	4.33	4.72
100x50	108.0x60.3	20	90	98*	150x65	165.1x76.1	20	110	120*
4x2	4.25x2.375	300	3.54	3.86	6x21/2	6.5x3	300	4.33	4.72
100x65	108.0x76.1	20	90	98*	150x80	165.1x88.9	20	110	120*
4x21/2	4.25x3	300	3.54	3.86	6x3	6.5x3.5	300	4.33	4.72
100x80	108x88.9	20	90	98*	150x100	165.1x114.3	20	110	120*
4x3	4.25x3.5	300	3.54	3.86	6x4	6.5x4.5	300	4.33	4.72
100x25	114.3x33.7	20	90	98*	150x40	168.3x48.3	20	110	120*
4x1	4.5x1.327	300	3.54	3.86	6x11/2	6.625x1.9	300	4.33	4.72
100x32	114.3x42.4	20	90	98*	150x50	168.3x60.3	20	110	120*
4x11/4	4.5x1.669	300	3.54	3.86	6x2	6.625x2.375	300	4.33	4.72
100x40	114.3x48.3	20	90	98*	150x65	168.3x76.1	20	110	120*
4x11/2	4.5x1.9	300	3.54	3.86	6x21/2	6.625x3	300	4.33	4.72
100x50	114.3x60.3	20	90	98*	150x80	168.3x88.9	20	110	120*
4x2	4.5x2.375	300	3.54	3.86	6x3	6.625x3.5	300	4.33	4.72
100x65	114.3x76.1	20	90	98*	150x100	168.3x114.3	20	110	120*
4x21/2	4.5x3	300	3.54	3.86	6x4	6.625x4.5	300	4.33	4.72
100x80	114.3x88.9	20	90	98*	200x50	219.1x60.3	20	146	146
4x3	4.5x3.5	300	3.54	3.86	8x2	8.625x2.375	300	5.75	5.75
125x50	133.0x60.3	20	105	105	200x50	219.1x76.1	20	146	146
5x2	5.25x2.375	300	4.13	4.13	8x21/2	8.625x3	300	5.75	5.75
125x65	133.0x76.1	20	105	105	200x80	219.1x88.9	20	146	146
5x21/2	5.25x3	300	4.13	4.13	8x3	8.625x3.5	300	5.75	5.75
125x80	133.0x88.9	20	105	105	200x100	219.1x114.3	20	146	146
5x3	5.25x3.5	300	4.13	4.13	8x4	8.625x4.5	300	5.75	5.75
125x100	133.0x114.3	20	105	105					
5x4	5.25x4.5	300	4.13	4.13					

MODEL XGQT05 GROOVED REDUCING CROSS

The grooved reducing cross are cast of ductile iron.

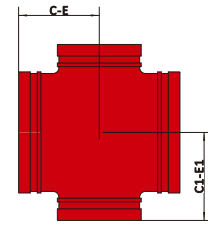

Nominal Size mm/in	Pipe O.D. mm/in	Max.Working Pressure Bar/PSI	Dimensions		Nominal Size mm/in	Pipe O.D. mm/in	Max.Working Pressure Bar/PSI	Dimensions	
			C-E mm/in	C1-E1 mm/in				C-E mm/in	C1-E1 mm/in
65x32	73x42.4	20	76	76	125x100	141.3x108	20	105	105
21/2x11/4	2.875x1.669	300	2.99	2.99	5x4	5.563x4.25	300	4.13	4.13
65x40	73x48.3	20	76	76	125x100	141.3x114.3	20	105	105
21/2x11/2	2.875x1.9	300	2.99	2.99	5x4	5.563x4.5	300	4.13	4.13
65x50	73x60.3	20	76	76	150x65	159x76.1	20	110	120
21/2x2	2.875x2.375	300	2.99	2.99	6x2 1/2	6.25x3	300	4.33	4.72
65x32	76.1x42.4	20	76	76	150x80	159x88.9	20	110	120
21/2x1/4	3x1.669	300	2.99	2.99	6x3	6.25x3.5	300	4.33	4.72
65x40	76.1x48.3	20	76	76	150x100	159x108	20	110	120
21/2x11/2	3x1.9	300	2.99	2.99	6x4	6.25x4.25	300	4.33	4.72
65x50	76.1x60.3	20	76	76	150x100	159x114.3	20	110	120
21/2x2	3x2.375	300	2.99	2.99	6x4	6.25x4.5	300	4.33	4.72
80x32	88.9x42.4	20	86	86	150x125	159x133	20	110	120
3x11/4	3.5x1.669	300	3.39	3.39	6x5	6.25x5.25	300	4.33	4.72
80x40	88.9x48.3	20	86	86	150x50	165.1x60.3	20	110	120
3x11/2	3.5x1.9	300	3.39	3.39	6x2	6.5x2.375	300	4.33	4.72
80x50	88.9x60.3	20	86	86	150x65	165.1x76.1	20	110	120
3x2	3.5x2.375	300	3.39	3.39	6x2 1/2	6.5x3	300	4.33	4.72
80x65	88.9x76.1	20	86	86	150x80	165.1x88.9	20	110	120
3x2 1/2	3.5x3	300	3.39	3.39	6x3	6.5x3.5	300	4.33	4.72
100x50	108x60.3	20	90	98	150x100	165.1x108	20	110	120
4x2	4.25x2.375	300	3.54	3.86	6x4	6.5x4.25	300	4.33	4.72
100x65	108x76.1	20	90	98	150x100	165.1x114.3	20	110	120
4x2 1/2	4.25x3	300	3.54	3.86	6x4	6.5x4.5	300	4.33	4.72
100x80	108x88.9	20	90	98	150x125	165.1x133	20	110	120
4x3	4.25x3.5	300	3.54	3.86	6x5	6.5x5.25	300	4.33	4.72
100x32	114.3x42.4	20	90	98	150x125	165.1x139.7	20	110	120
4x11/4	4.5x1.669	300	3.54	3.86	6x5	6.5x5.5	300	4.33	4.72
100x40	114.3x48.3	20	90	98	150x50	168.3x60.3	20	110	120
4x11/2	4.5x1.9	300	3.54	3.86	6x2	6.625x2.375	300	4.33	4.72
100x50	114.3x60.3	20	90	98	150x65	168.3x76.1	20	110	120
4x2	4.5x2.375	300	3.54	3.86	6x2 1/2	6.625x3	300	4.33	4.72
100x65	114.3x76.1	20	90	98	150x80	168.3x88.9	20	110	120
4x2 1/2	4.5x3	300	3.54	3.86	6x3	6.625x3.5	300	4.33	4.72
100x80	114.3x88.9	20	90	98	150x100	168.3x108	20	110	120
4x3	4.5x3.5	300	3.54	3.86	6x4	6.625x4.25	300	4.33	4.72
125x65	133x76.1	20	105	105	150x100	168.3x114.3	20	110	120
5x2 1/2	5.25x3	300	4.13	4.13	6x4	6.625x4.5	300	4.33	4.72
125x80	133x88.9	20	105	105	150x125	168.3x133	20	110	120
5x3	5.25x3.5	300	4.13	4.13	6x5	6.625x5.25	300	4.33	4.72
125x100	133x108	20	105	105	150x125	168.3x139.7	20	110	120
5x4	5.25x4.25	300	4.13	4.13	6x5	6.625x5.5	300	4.33	4.72
125x100	133x114.3	20	105	105	200x65	219.1x76.1	20	146	146
5x4	5.25x4.5	300	4.13	4.13	8x2 1/2	8.625x3	300	5.75	5.75
125x50	139.7x60.3	20	105	105	200x80	219.1x88.9	20	146	146
5x2	5.5x2.375	300	4.13	4.13	8x3	8.625x3.5	300	5.75	5.75
125x65	139.7x76.1	20	105	105	200x100	219.1x108	20	146	146
5x2 1/2	5.5x3	300	4.13	4.13	8x4	8.625x4.25	300	5.75	5.75
125x80	139.7x88.9	20	105	105	200x100	219.1x114.3	20	146	146
5x3	5.5x3.5	300	4.13	4.13	8x4	8.625x4.5	300	5.75	5.75
125x100	139.7x108	20	105	105	200x125	219.1x133	20	146	146
5x4	5.5x4.25	300	4.13	4.13	8x5	8.625x5.25	300	5.75	5.75
125x100	139.7x114.3	20	105	105	200x125	219.1x139.7	20	146	146
5x4	5.5x4.5	300	4.13	4.13	8x5	8.625x5.5	300	5.75	5.75
125x50	141.3x60.3	20	105	105	200x150	219.1x159	20	146	146
5x2	5.563x2.375	300	4.13	4.13	8x6	8.625x6.25	300	5.75	5.75
125x65	141.3x73	20	105	105	200x150	219.1x165.1	20	146	146
5x2 1/2	5.563x2.875	300	4.13	4.13	8x6	8.625x6.5	300	5.75	5.75
125x80	141.3x88.9	20	105	105					
5x3	5.563x3.5	300	4.13	4.13					

MODEL XGQT05S THREADED REDUCING CROSS

The threaded reducing cross are cast of ductile iron.

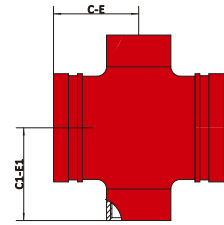

Nominal Size mm/in	Pipe O.D. mm/in	Max.Working Pressure Bar/PSI	Dimensions		Nominal Size mm/in	Pipe O.D. mm/in	Max.Working Pressure Bar/PSI	Dimensions	
			C-E mm/in	C1-E1 mm/in				C-E mm/in	C1-E1 mm/in
50x25	60.3x33.7	16	70	70	125x65	139.7x76.1	16	105	105
2x1	2.375x1.327	230	2.76	2.76	5x2 1/2	5.5x3	230	4.13	4.13
50x32	60.3x42.4	16	70	70	125x80	139.7x88.9	16	105	105
2x1 1/4	2.375x1.669	230	2.76	2.76	5x3	5.5x3.5	230	4.13	4.13
50x40	60.3x48.3	16	70	70	125x100	139.7x114.3	16	105	105
2x1 1/2	2.375x1.9	230	2.76	2.76	5x4	5.5x4.5	230	4.13	4.13
65x25	73.0x33.7	16	76	76	125x40	141.3x48.3	16	105	105
2 1/2x1	2.875x1.327	230	2.99	2.99	5x1 1/2	5.563x1.9	230	4.13	4.13
65x32	73.0x42.4	16	76	76	125x50	141.3x60.3	16	105	105
2 1/2x1 1/4	2.875x1.669	230	2.99	2.99	5x2	5.563x2.375	230	4.13	4.13
65x40	73.0x48.3	16	76	76	125x65	141.3x73	16	105	105
2 1/2x1 1/2	2.875x1.9	230	2.99	2.99	5x2 1/2	5.563x2.875	230	4.13	4.13
65x50	73.0x60.3	16	76	76	125x80	141.3x88.9	16	105	105
2 1/2x2	2.875x2.375	230	2.99	2.99	5x3	5.563x3.5	230	4.13	4.13
65x25	76.1x33.7	16	76	76	125x100	141.3x114.3	16	105	105
2 1/2x1	3x1.327	230	2.99	2.99	5x4	5.563x4.5	230	4.13	4.13
65x32	76.1x42.4	16	76	76	150x50	159.0x60.3	16	110	120*
2 1/2x1 1/4	3x1.669	230	2.99	2.99	6x2	6.250x2.375	230	4.33	4.72
65x40	76.1x48.3	16	76	76	150x65	159.0x76.1	16	110	120*
2 1/2x1 1/2	3x1.9	230	2.99	2.99	6x2 1/2	6.25x3	230	4.33	4.72
65x50	76.1x60.3	16	76	76	150x80	159.0x88.9	16	110	120*
2 1/2x2	3x2.375	230	2.99	2.99	6x3	6.25x3.5	230	4.33	4.72
80x25	88.9x33.7	16	86	86	150x100	159x114.3	16	110	120*
3x1	3.5x1.327	230	3.39	3.39	6x4	6.25x4.5	230	4.33	4.72
80x32	88.9x42.4	16	86	86	150x40	165.1x48.3	16	110	120*
3x1 1/4	3.5x1.669	230	3.39	3.39	6x1 1/2	6.5x1.9	230	4.33	4.72
80x40	88.9x48.3	16	86	86	150x50	165.1x60.3	16	110	120*
3x1 1/2	3.5x1.9	230	3.39	3.39	6x2	6.5x2.375	230	4.33	4.72
80x50	88.9x60.3	16	86	86	150x65	165.1x76.1	16	110	120*
3x2	3.5x2.375	230	3.39	3.39	6x2 1/2	6.5x3	230	4.33	4.72
80x65	88.9x76.1	16	86	86	150x80	165.1x88.9	16	110	120*
3x2 1/2	3.5x3	230	3.39	3.39	6x3	6.5x3.5	230	4.33	4.72
100x50	108.0x60.3	16	90	98	150x100	165.1x114.3	16	110	120*
4x2	4.25x2.375	230	3.54	3.86	6x4	6.5x4.5	230	4.33	4.72
100x65	108.0x76.1	16	90	98	150x40	168.3x48.3	16	110	120*
4x2 1/2	4.25x3	230	3.54	3.86	6x1 1/2	6.625x1.9	230	4.33	4.72
100x80	108x88.9	16	90	98	150x50	168.3x60.3	16	110	120*
4x3	4.25x3.5	230	3.54	3.86	6x2	6.625x2.375	230	4.33	4.72
100x25	114.3x33.7	16	90	98	150x65	168.3x76.1	16	110	120*
4x1	4.5x1.327	230	3.54	3.86	6x2 1/2	6.625x3	230	4.33	4.72
100x32	114.3x42.4	16	90	98	150x80	168.3x88.9	16	110	120*
4x1 1/4	4.5x1.669	230	3.54	3.86	6x3	6.625x3.5	230	4.33	4.72
100x40	114.3x48.3	16	90	98	150x100	168.3xRc4	16	110	120*
4x1 1/2	4.5x1.9	230	3.54	3.86	6x4	6.625x4.5	230	4.33	4.72
100x50	114.3x60.3	16	90	98	200x50	219.1x60.3	16	146	146
4x2	4.5x2.375	230	3.54	3.86	8x2	8.625x2.375	230	5.75	5.75
100x65	114.3x76.1	16	90	98	200x50	219.1x76.1	16	146	146
4x2 1/2	4.5x3	230	3.54	3.86	8x2 1/2	8.625x3	230	5.75	5.75
100x80	114.3x88.9	16	90	98	200x80	219.1x88.9	16	146	146
4x3	4.5x3.5	230	3.54	3.86	8x3	8.625x3.5	230	5.75	5.75
125x40	139.7x48.3	16	105	105	200x100	219.1x114.3	16	146	146
5x1 1/2	5.5x1.9	230	4.13	4.13	8x4	8.625x4.5	230	5.75	5.75
125x50	139.7xRc2	16	105	105					
5x2	5.5x2.375	230	4.13	4.13					

MODEL XGQT014 90° REDUCING ELBOW

The Model XGQT014 is a ductile iron 90° grooved-end elbow with base support, designed for installation at the bottom of a riser system. An anchor can be placed in conjunction with the base to support the weight of the pipe, coupling and fluid.

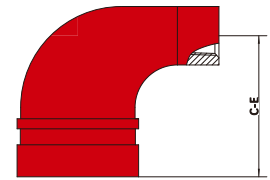

Nominal Size mm/in	NPT/BSP	Max.Working Pressure Bar/PSI	C - E mm/in
32×15	15	20	61
11/4×1/2	1/2	300	2.40
32×20	20	20	61
11/4×3/4	3/4	300	2.40
32×25	25	20	61
11/4×1	1	300	2.40
40×15	15	20	64
11/2×1/2	1/2	300	2.52
40×20	20	20	64
11/2×3/4	3/4	300	2.52
40×25	25	20	64
11/2×1	1	300	2.52
50×15	15	20	70
2×1/2	1/2	300	2.76
50×20	20	20	70
2×3/4	3/4	300	2.76
50×25	25	20	70
2×1	1	300	2.76
65×15	15	20	76
21/2×1/2	1/2	300	2.99
65×20	20	20	76
21/2×3/4	3/4	300	2.99
65×25	25	20	76
21/2×1	1	300	2.99

MODEL 900 END-ALL FITTING

The Model 900 End-All fitting is a unique domed end cap fitting available with 1/2", 3/4" and 1" NPT or BSP threaded outlets. Designed as an end of line fitting the End-All features two multi-function bosses which can be used for the direct connection of sprinkler heads, sprigs, drops, drains and or gauges.

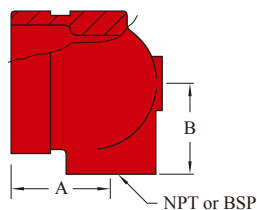

Nominal Size Grooved X Threaded mm/in	Max.Working Pressure Bar/PSI	Dimensions	
		A mm/in	B mm/in
32×15	20	44.5	30.1
1.25×0.5	300	1.750	1.190
32×20	20	44.5	30.1
1.25×0.75	300	1.750	1.190
32×25	20	48.3	31.8
1.25×1	300	1.900	1.250
40×15	20	44.5	33.3
1.5×0.5	300	1.750	1.313
40×20	20	44.5	33.3
1.5×0.75	300	1.750	1.313
40×25	20	48.3	34.9
1.5×1	300	1.900	1.375
50×15	20	44.5	39.7
2×0.5	300	1.750	1.562
50×20	20	44.5	39.7
2×0.75	300	1.750	1.562
50×25	20	48.3	41.3
2×1	300	1.900	1.625
65×15	20	44.5	44.5
2.5×0.5	300	1.750	1.750
65×20	20	44.5	44.5
2.5×3/4	300	1.750	1.750
65×25	20	48.3	46.0
2.5×1	300	1.900	1.813

MODEL XGQT07 GROOVED CONCENTRIC REDUCER

The concentric reducer is cast of ductile iron. The end-to-end dimensions of these reducers are less than that of fabricated reducers.



Nominal Size mm/in	Pipe O.D. mm/in	Max.Working Pressure Bar/PSI	E - E mm/in
40x32	48.3x42.4	20	64
11/2x11/4	1.9x1.669	300	2.52
50x32	60.3x42.4	20	64
2x11/4	2.375x1.669	300	2.52
50x40	60.3x48.3	20	64
2x11/2	2.375x1.9	300	2.52
65x32	73x42.4	20	64
21/2x11/4	2.875x1.669	300	2.52
65x40	73x48.3	20	64
21/2x11/2	2.875x1.9	300	2.52
65x50	73x60.3	20	64
21/2x2	2.875x2.375	300	2.52
65x40	76.1x48.3	20	64
21/2x11/2	3x1.9	300	2.52
65x50	76.1x60.3	20	64
21/2x2	3x2.375	300	2.52
80x32	88.9x42.4	20	64
3x11/4	3.5x1.669	300	2.52
80x40	88.9x48.3	20	64
3x11/2	3.5x1.9	300	2.52
80x50	88.9x60.3	20	64
3x2	3.5x2.375	300	2.52
80x65	88.9x73	20	64
3x21/2	3.5x2.875	300	2.52
80x65	88.9x76.1	20	64
3x21/2	3.5x3	300	2.52
100x32	114.3x42.4	20	76
4x11/4	4.5x1.669	300	2.99
100x40	114.3x48.3	20	76
4x11/2	4.5x1.9	300	2.99
100x50	114.3x60.3	20	76
4x2	4.5x2.375	300	2.99
100x65	114.3x73	20	76
4x21/2	4.5x2.875	300	2.99
100x65	114.3x76.1	20	76
4x21/2	4.5x3	300	2.99
100x80	114.3x88.9	20	76
4x3	4.5x3.5	300	2.99
125x50	133x60.3	20	85
5x2	5.25x2.375	300	3.35
125x50	139.7x60.3	20	85
5x2	5.5x2.375	300	3.35
125x65	139.7x73	20	85
5x21/2	5.5x2.875	300	3.35
125x65	139.7x76.1	20	85
5x21/2	5.5x3	300	3.35
125x80	139.7x88.9	20	85
5x3	5.5x3.5	300	3.35
125x100	139.7x108	20	85
5x4	5.5x4.25	300	3.35
125x100	139.7x114.3	20	85
5x4	5.5x4.5	300	3.35
125x50	141.3x60.3	20	85
5x2	5.563x2.375	300	3.35
125x65	141.3x73	20	85
5x21/2	5.563x2.875	300	3.35
125x65	141.3x76.1	20	85
5x21/2	5.563x3	300	3.35
125x80	141.3x88.9	20	85
5x3	5.563x3.5	300	3.35
125x100	141.3x114.3	20	85
5x4	5.563x4.5	300	3.35
150x50	159x60.3	20	85
6x2	6.25x2.375	300	3.35
150x100	159x108	20	85
6x4	6.25x4.25	300	3.35

Nominal Size mm/in	Pipe O.D. mm/in	Max.Working Pressure Bar/PSI	E - E mm/in
150x100	159x114.3	20	85
6x4	6.25x4.5	300	3.35
150x125	159x139.7	20	85
6x5	6.25x5.5	300	3.35
150x50	165.1x60.3	20	85
6x2	6.5x2.375	300	3.35
150x65	165.1x73	20	85
6x21/2	6.5x2.875	300	3.35
150x65	165.1x76.1	20	85
6x21/2	6.5x3	300	3.35
150x100	165.1x108	20	85
6x4	6.5x4.25	300	3.35
150x100	165.1x114.3	20	85
6x4	6.5x4.5	300	3.35
150x125	165.1x133	20	85
6x5	6.5x5.25	300	3.35
150x125	165.1x139.7	20	85
6x5	6.5x5.5	300	3.35
150x50	168.3x60.3	20	85
6x2	6.63x2.375	300	3.35
150x65	168.3x73	20	85
6x21/2	6.625x2.875	300	3.35
150x65	168.3x76.1	20	85
6x21/2	6.625x2.375	300	3.35
150x80	168.3x88.9	20	85
6x3	6.625x3.5	300	3.35
150x100	168.3x114.3	20	85
6x4	6.625x4.5	300	3.35
150x125	168.3x139.7	20	85
6x5	6.625x5.5	300	3.35
200x65	219.1x76.1	20	85
8x21/2	8.63x3	300	3.35
200x80	219.1x88.9	20	85
8x3	8.625x3.5	300	3.35
200x100	219.1x114.3	20	85
8x4	8.625x4.5	300	3.35
200x125	219.1x139.7	20	85
8x5	8.625x5.5	300	3.35
200x150	219.1x159	20	85
8x6	8.625x6.25	300	3.35
200x150	219.1x165.1	20	85
8x6	8.63x6.5	300	3.35
200x150	219.1x168.3	20	85
8x6	8.625x6.63	300	3.35
250x100	273x114.3	20	90
10x4	10.75x4.5	300	3.54
250x125	273x139.7	20	90
10x5	10.75x5.5	300	3.54
250x150	273x159	20	90
10x6	10.75x6.25	300	3.54
250x150	273x165.1	20	90
10x6	10.75x6.5	300	3.54
250x200	273x219.1	20	90
10x8	10.75x8.625	300	3.54
300x100	323.9x114.3	20	90
12x4	12.75x4.5	300	3.54
300x125	323.9x139.7	20	90
12x5	12.75x5.5	300	3.54
300x150	323.9x159	20	90
12x6	12.75x6.25	300	3.54
300x150	323.9x165.1	20	90
12x6	12.75x6.625	300	3.54
300x200	323.9x219.1	20	90
12x8	12.75x8.63	300	3.54
300x250	323.9x273	20	90
12x10	12.75x10.75	300	3.54

MODEL XGQT07S THREADED CONCENTRIC REDUCER

The concentric reducer is cast of ductile iron. The end-to-end dimensions of these reducers are less than that of fabricated reducers.

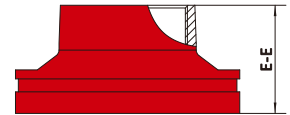

Nominal Size mm/in	Pipe O.D. mm/in	Max. Working Pressure Bar/PSI	E - E mm/in	Nominal Size mm/in	Pipe O.D. mm/in	Max. Working Pressure Bar/PSI	E - E mm/in
50x25	60.3x33.7	16	64	125x65	139.7x76.1	16	85
2x1	2.375x1.327	230	2.52	5x2 1/2	5.5x3	230	3.35
50x32	60.3x42.4	16	64	125x80	139.7x88.9	16	85
2x1 1/4	2.375x1.669	230	2.52	5x3	5.5x3.5	230	3.35
50x40	60.3x48.3	16	64	125x100	139.7x114.3	16	85
2x1 1/2	2.375x1.9	230	2.52	5x4	5.5x4.5	230	3.35
65x25	73x33.7	16	64	125x25	141.3x33.7	16	85
2 1/2x1	2.875x1.327	230	2.52	5x1	5.563x1.327	230	3.35
65x32	73x42.4	16	64	125x32	141.3x42.4	16	85
2 1/2x1 1/4	2.875x1.669	230	2.52	5x1 1/4	5.563x1.669	230	3.35
65x40	73x48.3	16	64	125x40	141.3x48.3	16	85
2 1/2x1 1/2	2.875x1.9	230	2.52	5x1 1/2	5.563x1.9	230	3.35
65x50	73x60.3	16	64	125x50	141.3x60.3	16	85
2 1/2x2	2.875x2.375	230	2.52	5x2	5.563x2.375	230	3.35
65x25	76.1x33.7	16	64	125x65	141.3x73	16	85
2 1/2x1	3x1.327	230	2.52	5x2 1/2	5.563x2.875	230	3.35
65x32	76.1x42.4	16	64	125x80	141.3x88.9	16	85
2 1/2x1 1/4	3x1.669	230	2.52	5x3	5.563x3.5	230	3.35
65x40	76.1x48.3	16	64	125x80	141.3x114.3	16	85
2 1/2x1 1/2	3x1.9	230	2.52	5x3	5.563x4.5	230	3.35
65x50	76.1x60.3	16	64	150x25	165.1x33.7	16	85
2 1/2x2	3x2.375	230	2.52	6x1	6.5x1.327	230	3.35
80x25	88.9x33.7	16	64	150x32	165.1x42.4	16	85
3x1	3.5x1.327	230	2.52	6x1 1/4	6.5x1.669	230	3.35
80x32	88.9x42.4	16	64	150x40	165.1x48.3	16	85
3x1 1/4	3.5x1.669	230	2.52	6x1 1/2	6.5x1.9	230	3.35
80x40	88.9x48.3	16	64	150x50	165.1x60.3	16	85
3x1 1/2	3.5x1.9	230	2.52	6x2	6.5x2.375	230	3.35
80x50	88.9x60.3	16	64	150x65	165.1x76.1	16	85
3x2	3.5x2.375	230	2.52	6x2 1/2	6.5x3	230	3.35
80x65	88.9x76.1	16	64	150x80	165.1x88.9	16	85
3x2 1/2	3.5x3	230	2.52	6x3	6.5x3.5	230	3.35
100x25	108.0x33.7	16	76	150x100	165.1x114.3	16	85
4x1	4.25x1.327	230	2.99	6x4	6.5x4.5	230	3.35
100x32	108.0x42.4	16	76	150x25	168.3x33.7	16	85
4x1 1/4	4.25x1.669	230	2.99	6x1	6.625x1.327	230	3.35
100x40	108.0x48.3	16	76	150x32	168.3x42.4	16	85
4x1 1/2	4.25x1.9	230	2.99	6x1 1/4	6.625x1.669	230	3.35
100x50	108.0x60.3	16	76	150x40	168.3x48.3	16	85
4x2	4.25x2.375	230	2.99	6x1 1/2	6.625x1.9	230	3.35
100x65	108.0x76.1	16	76	150x50	168.3x60.3	16	85
4x2 1/2	4.25x3	230	2.99	6x2	6.625x2.375	230	3.35
100x80	108x88.9	16	76	150x65	168.3x73	16	85
4x3	4.25x3.5	230	2.99	6x2 1/2	6.625x2.875	230	3.35
100x25	114.3x33.7	16	76	150x65	168.3x76.1	16	85
4x1	4.5x1.327	230	2.99	6x2 1/2	6.625x3	230	3.35
100x32	114.3x42.4	16	76	150x80	168.3x88.9	16	85
4x1 1/4	4.5x1.669	230	2.99	6x3	6.625x3.5	230	3.35
100x40	114.3x48.3	16	76	150x100	168.3x114.3	16	85
4x1 1/2	4.5x1.9	230	2.99	6x4	6.625x4.5	230	3.35
100x50	114.3x60.3	16	76	200x25	219.1x33.7	16	85
4x2	4.5x2.375	230	2.99	8x1	8.625x1.327	230	3.35
100x65	114.3x73	16	76	200x32	219.1x42.4	16	85
4x2 1/2	4.5x2.875	230	2.99	8x1 1/4	8.625x1.669	230	3.35
100x65	114.3x76.1	16	76	200x40	219.1x48.3	16	85
4x2 1/2	4.5x3	230	2.99	8x1 1/2	8.625x1.9	230	3.35
100x80	114.3x88.9	16	76	200x50	219.1x60.3	16	85
4x3	4.5x3.5	230	2.99	8x2	8.625x2.375	230	3.35
125x25	139.7x33.7	16	85	200x65	219.1x73	16	85
5x1	5.5x1.327	230	3.35	8x2 1/2	8.625x2.875	230	3.35
125x32	139.7x42.4	16	85	200x65	219.1x76.1	16	85
5x1 1/4	5.5x1.669	230	3.35	8x2 1/2	8.625x3	230	3.35
125x40	139.7x48.3	16	85	200x80	219.1x88.9	16	85
5x1 1/2	5.5x1.9	230	3.35	8x3	8.625x3.5	230	3.35
125x50	139.7x60.3	16	85	200x100	219.1x114.3	16	85
5x2	5.5x2.375	230	3.35	8x4	8.625x4.5	230	3.35

MODEL XGQT06 END CAP

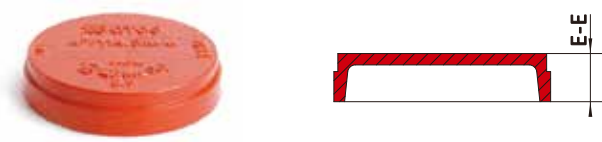

Nominal Size mm/in	Pipe O.D. mm/in	Max. Working Pressure Bar/PSI	E - E mm/in
25	33.7	20	23.8
1	1.327	300	0.94
32	42.4	20	23.8
11/4	1.669	300	0.94
40	48.3	20	23.8
11/2	1.9	300	0.94
50	60.3	20	23.8
2	2.375	300	0.94
65	76.1	20	23.8
21/2	3	300	0.94
80	88.9	20	23.8
3	3.5	300	0.94
100	108	20	25.4
4	4.25	300	1.00
100	114.3	20	25.4
4	4.5	300	1.00
125	133	20	25.4
5	5.25	300	1.00
125	139.7	20	25.4
5	5.5	300	1.00
125	141.3	20	25.4
5	5.563	300	1.00
150	159	20	25.4
5	6.25	300	1.00
150	165.1	20	25.4
6	6.5	300	1.00
150	168.3	20	25.4
6	6.625	300	1.00
200	219.1	20	30.2
8	8.625	300	1.19
250	273	20	32
10	10.75	300	1.26
300	323.9	20	32
12	12.75	300	1.26

MODEL XGQT061 TRANSITION CAP (Gr X FT)

The Model XGQT061 is an ideal transition fitting when a large reduction is required such as 6"×1", 4"×1" etc. The XGQT061 can be used as an alternative to expensive swaged nipples.



Nominal Size Grooved X Threaded mm/in	Pipe O.D. mm/in	Max. Working Pressure Bar/PSI	E - E mm/in
50×25	60.3×33.7	20	23.8
2×1	2.375×1.327	300	0.94
50×32	60.3×42.4	20	23.8
2×11/4	2.375×1.669	300	0.94
50×40	60.3×48.3	20	23.8
2×11/2	2.375×1.9	300	0.94
65×25	73×33.7	20	23.8
21/2×1	2.875×1.327	300	0.94
65×32	73×42.4	20	23.8
21/2×11/4	2.875×1.669	300	0.94
65×40	73×48.3	20	23.8
21/2×11/2	2.875×1.9	300	0.94
65×50	73.0×60.3	20	23.8
21/2×2	2.875×2.375	300	0.94
65×25	76.1×33.7	20	23.8
21/2×1	3×1.327	300	0.94
65×32	76.1×42.4	20	23.8
21/2×11/4	3×1.669	300	0.94
65×40	76.1×48.3	20	23.8
21/2×11/2	3×1.9	300	0.94
65×50	76.1×60.3	20	23.8
21/2×2	3×2.375	300	0.94
80×25	88.9×33.7	20	23.8
3×1	3.5×1.327	300	0.94
80×32	88.9×42.4	20	23.8
3×11/4	3.5×1.669	300	0.94
80×40	88.9×48.3	20	23.8
3×11/2	3.5×1.9	300	0.94
80×50	88.9×60.3	20	23.8
3×2	3.5×2.375	300	0.94
100×25	114.3×33.7	20	25.4
4×1	4.5×1.327	300	1.00
100×32	114.3×42.4	20	25.4
4×11/2	4.5×1.669	300	1.00
100×40	114.3×48.3	20	25.4
4×11/2	4.5×1.9	300	1.00
100×50	114.3×60.3	20	25.4
4×2	4.5×2.375	300	1.00
125×50	139.7×60.3	20	25.4
5×2	5.5×2.375	300	1.00
125×50	141.3×60.3	20	25.4
5×2	5.563×2.375	300	1.00
150×25	165.1×33.7	20	25.4
6×1	6.5×1.327	300	1.00
150×50	165.1×60.3	20	25.4
6×2	6.5×2.375	300	1.00
150×32	168.3×42.4	20	25.4
6×11/4	6.625×1.669	300	1.00
150×40	168.3×48.3	20	25.4
6×11/2	6.63×1.9	300	1.00
150×50	168.3×60.3	20	25.4
6×2	6.63×2.375	300	1.00
200×50	219.1×60.3	20	30.2
8×2	8.625×2.375	300	1.19

MODEL 1100 RING JOINT COUPLING

The ring joint piping system is an ideal pipe joining method where pipe is difficult to groove or when grooving is not the preferred method. First weld a factory-supplied ring on each pipe end, next mount the rubber gasket over the pipe ends, place coupling segments over the gasket and fasten bolts and nuts. The Lede Model 1100 ring joint coupling is supplied with a pair of factory rings.

The 1100 is a shouldered type coupling that meets or exceeds the design and performance requirements of the AWWA C606 standard.

Standard applications include:

Water & waste water treatment plants, mining, pulp & paper, hydroelectric plants, Co-Gen electric plants, food and beverage and compressed air.

Working pressures:

20 Bar / 300 psi (200mm- 600mm / 8" - 24")

(Factory test pressure: 60 Bars / 900 psi)

The 1100 coupling can be used on stainless steel pipe where applicable. Stainless steel rings of the same grade as the pipe should be used and are available as an option.

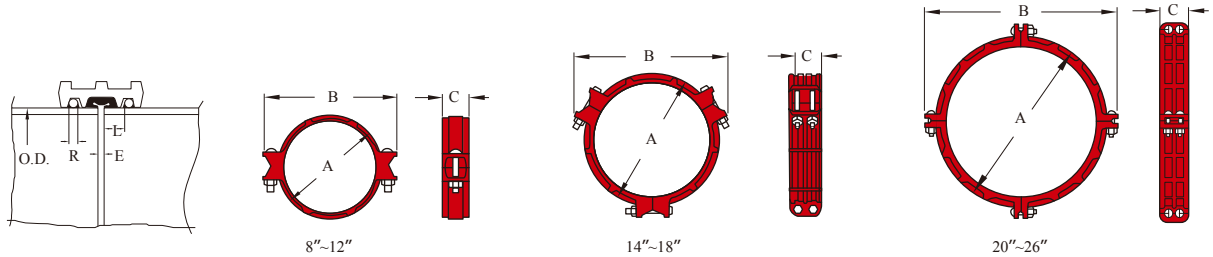

Nominal Size mm/in	Pipe O.D. mm/in	Dimensions			Bolts		Sealing Surface L (mm/in)	Ring Size R (mm/in)	Separation E (max) mm/in	Pipe End Deflection Deg.
		A mm/in	B mm/in	C mm/in	No.	in				
200	216.3	253	327	79	2	M20×120	23	6	4.8	1°-51'
8 JIS	8.516	9.96	12.87	3.11			0.91	0.24	0.19	
200	219.1	256	330	79	2	3/4×4-3/4	23	6	4.8	1°-51'
8	8.625	10.08	13	3.11			0.91	0.24	0.19	
250	267.4	306	380	83	2	M20×120	23	6	4.8	1°-29'
10 JIS	10.528	12.05	14.96	3.25			0.91	0.24	0.19	
250	273.0	312	386	83	2	3/4×4-3/4	23	6	4.8	1°-29'
10	10.750	12.29	15.2	3.25			0.91	0.24	0.19	
300	318.5	369	450	86	2	M22×165	26	7	4.8	1°-15'
12 JIS	12.539	14.53	17.72	3.39			1.02	0.28	0.19	
300	323.9	374	455	86	2	7/8×6-1/2	26	8	4.8	1°-15'
12	12.750	14.72	17.90	3.39			1.02	0.28	0.19	
350	355.6	420	502	115	6	5/8×5-5/16	26	8	9.5	1°-17'
14	14.000	16.50	19.73	4.52			1.02	5/16	0.375	
400	406.4	470	552	225	6	5/8×5-5/16	26	8	9.5	1°-16'
16	16.000	18.50	21.69	4.52			1.02	5/16	0.375	
450	457.2	521	603	115	6	3/4×4-3/4	30	8	9.5	1°-7'
18	18.000	20.50	23.70	4.52			1.18	5/16	0.375	
500	508.0	585	676	122	8	7/8×3-1/2	30	9.5	9.5	1°-0'
20	20.000	23.00	26.60	4.79			1.18	3/8	0.375	
600	609.6	686	781	122	8	7/8×3-1/2	30	12.7	9.5	0°-54'
24	24.000	27.00	30.69	4.79			1.18	1/2	0.375	

* Dimensions are subject to change without notice. Other sizes are available upon request.

PLAIN-END HDP PIPING SYSTEM

The HDP series of piping components are designed to provide a fast and easy way to mechanically join HDP (high density polyethylene/polybutylene) pipe.

These components are designed to join HDP pipe and fittings conforming to ASTM D2447, D3000, D3035 or F-714, at ambient temperatures with wall thicknesses from SDR 32.5

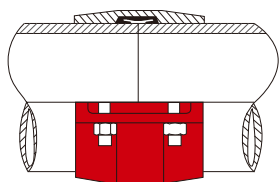

This method eliminates the need for costly heat fusion equipment, solvent joining and or complicated adapters. The HDP piping components are rated to the same pressure as that of the HDP pipe they are used in conjunction with.

Note: The Lede HDP couplings are not intended for use on PVC or other materials.



MARKING: Use a marking pen or other marking tool and measuring tape to place marks on each pipe end, 1" from each end.

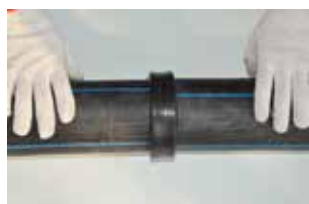

GASKET MOUNTING: Place a gasket over the pipe ends and center the gasket in between the mark*. The pipe ends should always be butted against each other.



HOUSING MOUNTING: Place the housings over gasket and insert bolts. Then apply nuts finger tight.



NUT TIGHTENING: Tighten the nuts alternatively until the housing bolt pads meet metal to metal.

* We recommend the use of a silicone based lubricant for use with the HDP series.

MODEL HDP COUPLING

The Model HDP couplings feature four bolt housings and a series of sharply machined teeth which positively grip the pipe as the coupling housing is tightened. The result is a leak-tight joint that is as strong or

stronger than the pipe itself. It also features a contoured housing with integral ramps along the outside diameter to help the coupling slide over most obstacles during the relocation of pipe runs.

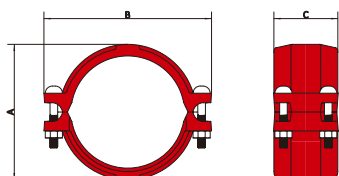

Pipe O.D. mm/in		Dimensions			Bolt	
		A mm/in	B mm/in	C mm/in	No.	Size mm/in
63	63.6	85	128	105	4	M10x55
2.48	2.50	3.35	5.04	4.13		3/8x2-1/8
90	90.9	110	169	105	4	M12x75
3.54	3.58	4.33	6.65	4.13		1/2x3
110	111	138	181	113	4	M12x75
4.33	4.37	5.43	7.13	4.45		1/2x3
160	161.5	190	261	147	4	M16x90
6.30	6.36	7.48	10.28	5.79		5/8x3-1/2
200	201.8	233	319	154	4	M16x90
7.87	7.94	9.17	12.56	6.06		5/8x3-1/2
250	252.3	287	351	136	4	M16x120
9.84	9.93	11.30	13.82	5.35		5/8x4-3/4
315	317.9	351	442	136	4	M20x120
12.40	12.52	13.82	17.40	5.35		3/4x4-3/4

MECHANICAL TEE

The hole-cut mechanical tee provides a fast and easy mid-point branch outlet without welding. First a hole is cut or drilled at the desired outlet location. The mechanical tee is then positioned so that the built-in locating collar fits within the hole. As the housing bolts are tightened the pressure moulded gasket forms a leak-tight seal. Use of the Lede mechanical tee can eliminate the need for multiple couplings and fittings.



- We offers a full range of mechanical tees:
- Model XGQT04: Threaded outlet, NPT or BSPT (ISO 7-1) pipe threads
 - Model XGQT04G: Cut-grooved outlet (machined)
 - Model L922 and 041: Saddle-Let; Small mechanical tee with threaded outlet, NPT or BSPT (ISO 7-1) pipe threads

Caution: Piping practices require that main and branch connections are at a true 90° angle. Also be certain that the locating collar is securely positioned inside the outlet hole before tightening the housing. When mechanical tees or mechanical crosses are used as transition pieces between two runs, the tees or crosses shall be assembled prior to making the branch connections.

MODEL 041 SADDLE-LET (U bolt Mechanical Tee)

The Model 041 Saddle-Lets is the ideal outlet fitting for direct connections to sprinkler heads, drop nipples and or gauges. No need for welding, just cut or drill a hole at the desired outlet location. Position the Saddle-Let so that the locating collar fits within the hole and secure with the U-bolt and nuts. The Saddle-Let comes with a standard black finish or as an option can be supplied electro zinc plated or painted orange. The Saddle-Let allows full bore flow and is pressure rates to 300 psi (20 bar).

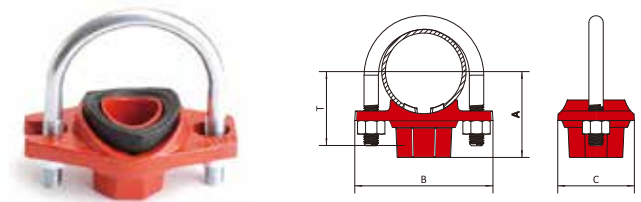

Nominal Size mm/in	Hole Dia. \bar{F} +1,-0 / +0.04,-0	Dimensions - mm/in			Take-Out T/D mm/in	Bolt Size in	Bolt Torque N-M/Lbs-Ft
		A	B	C			
25x15	24	46	74	44	40	5/16 Φ	25-30
1x1/2	0.95	1.81	2.91	1.73	1.57	U-Bolt	18-22
25x20	24	46	74	44	40	5/16 Φ	25-30
1x3/4	0.95	1.81	2.91	1.73	1.57	U-Bolt	18-22
32x15	30	53	89	56	44	3/8 Φ	30-40
11/4x1/2	1.18	2.09	3.50	2.20	1.73	U-Bolt	22-29
32x20	30	53	89	56	44	3/8 Φ	30-40
11/4x3/4	1.18	2.09	3.50	2.20	1.73	U-Bolt	22-29
32x25	30	56	89	56	47	3/8 Φ	30-40
11/4x1	1.18	2.20	3.50	2.20	1.85	U-Bolt	22-29
40x15	30	55	89	56	46	3/8 Φ	30-40
11/2x1/2	1.18	2.17	3.50	2.20	1.81	U-Bolt	22-29
40x20	30	55	89	56	46	3/8 Φ	30-40
11/2x3/4	1.18	2.17	3.50	2.20	1.81	U-Bolt	22-29
40x25	30	58	89	56	49	3/8 Φ	30-40
11/2x1	1.18	2.28	3.50	2.20	1.93	U-Bolt	22-29
50x15	30	64	98	56	53	3/8 Φ	30-40
2x1/2	1.18	2.52	3.86	2.20	2.09	U-Bolt	22-29
50x20	30	64	98	56	53	3/8 Φ	30-40
2x3/4	1.18	2.52	3.86	2.20	2.09	U-Bolt	22-29
50x25	30	67	98	56	56	3/8 Φ	30-40
2x1	1.18	2.64	3.86	2.20	2.20	U-Bolt	22-29
65x15	30	69	111	56	58	3/8 Φ	30-40
21/2x1/2	1.18	2.72	4.37	2.20	2.28	U-Bolt	22-29
65x20	30	69	111	56	58	3/8 Φ	30-40
21/2x3/4	1.18	2.72	4.37	2.20	2.28	U-Bolt	22-29
65x25	30	72	111	56	61	3/8 Φ	30-40
21/2x1	1.18	2.83	4.37	2.20	2.40	U-Bolt	22-29
80x25	30	80.5	128	56	67	3/8 Φ	30-40
3x1	1.18	3.17	5.04	2.20	2.64	U-Bolt	22-29

MODEL L922 SADDLE-LET (Small Mechanical Tee)

The Model L922 Saddle-Lets is the ideal outlet fitting for direct connections to sprinkler heads, drop nipples and or gauges. No need for welding, just cut or drill a hole at the desired outlet location. Position the Saddle-Let so that the locating collar fits within the hole, then tighten the upper and lower housings with bolts and nuts. The Saddle-Let comes with a standard black finish or as an option can be supplied electro zinc plated or painted orange. The Saddle-Let allows full bore flow and is pressure rates to 300 psi (20 bar).

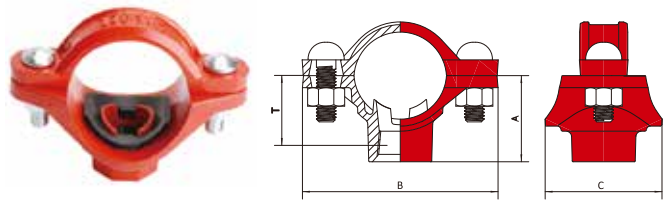

Nominal Size mm/in	Hole Dia. Φ +1,-0 / +0.04,-0	Dimensions - mm/in			Take-Out T/D mm/in	Bolt Size in	Bolt Torque N-M/Lb-Ft
		A	B	C			
25x15	24	28	93	48	29	3/8 Φ	30-40
1x1/2	0.95	1.10	3.66	1.89	1.14	U-Bolt	22-29
32x15	30.00	45	98	65	33	3/8 Φ	30-40
11/4x1/2	1.18	1.77	3.86	2.56	1.30	U-Bolt	22-29
32x20	30.00	45	98	65	32.5	3/8 Φ	30-40
11/4x3/4	1.18	1.77	3.86	2.56	1.28	U-Bolt	22-29
32x25	30.00	54	98	65	38.6	3/8 Φ	30-40
11/4x1	1.18	2.13	3.86	2.56	1.52	U-Bolt	22-29
40x15	30.00	48	105.6	65	36.1	3/8 Φ	30-40
11/2x1/2	1.18	1.89	4.16	2.56	1.42	U-Bolt	22-29
40x20	30.00	48	105.6	65	35.6	3/8 Φ	30-40
11/2x3/4	1.18	1.89	4.16	2.56	1.40	U-Bolt	22-29
40x25	30.00	57	105.6	65	41.7	3/8 Φ	30-40
11/2x1	1.18	2.24	4.16	2.56	1.64	U-Bolt	22-29
50x15	30.00	54	125	65	42.2	3/8 Φ	30-40
2x1/2	1.18	2.13	4.92	2.56	1.66	U-Bolt	22-29
50x20	30.00	54	125	65	41.7	3/8 Φ	30-40
2x3/4	1.18	2.13	4.92	2.56	1.64	U-Bolt	22-29
50x25	30.00	62	125	65	47.8	3/8 Φ	30-40
2x1	1.18	2.44	4.92	2.56	1.88	U-Bolt	22-29
65x15	30.00	61	139	65	48.5	3/8 Φ	30-40
21/2x1/2	1.18	2.40	5.47	2.56	1.91	U-Bolt	22-29
65x20	30.00	61	139	65	48	3/8 Φ	30-40
21/2x3/4	1.18	2.40	5.47	2.56	1.89	U-Bolt	22-29
65x25	30.00	71	139	65	54.1	3/8 Φ	30-40
21/2x1	1.18	2.80	5.47	2.56	2.13	U-Bolt	22-29

1. Drill a hole on the pipe according to the hole sizes requirements, ensure all the burrs are removed, and no deep pits or swells are found within 20mm around the hole.



2. Put the gasket into the upper housing, and make sure it is suitable for the intended service.



XGQT04G XGQT04 L922

3. Put the upper parts above the pipe hole, then put the location collar fit into the hole, ensure the gasket to cover the hole evenly.



XGQT04G XGQT04 L922

4. Place the lower housing opposite to the pipe, align the upper housing and lower housing, then insert the bolts.



XGQT04G XGQT04 L922

5. Tighten the nuts evenly until the upper housing touches the pipe well, the torque of the nuts should be in accordance with the requirements of LEDE company.



XGQT04G XGQT04 L922

6. After installation, check it carefully to make sure the gap between upper part and lower part is equal and tiny.



XGQT04G XGQT04 L922

When mechanical cross is installed, make sure the deflection of the upper housing and lower housing cannot be beyond 1.0mm, and the both location collar are in the center of the hole, when nuts tightened, the torque must be in accordance with the LEDE requirements.

MODEL XGQT04 MECHANICAL TEE THREADED OUTLET

The Model XGQT04 Mechanical Tee provides a fast and easy mid-pipe threaded branch outlet. The XGQT04 eliminates the need for welding or multiple fittings. The mechanical tee utilizes ductile iron housings, a grade E

moulded gasket and heat-treated carbon steel track bolts and nuts. Housings are painted orange or red, or as an option can be supplied hot-dipped zinc galvanized or epoxy coated. Pressure rated to 300 psi (20 bar).

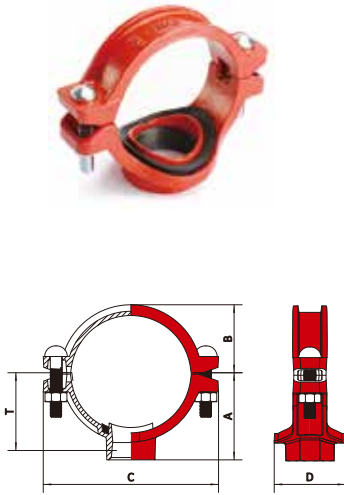

Nominal Size mm/in	Pipe O.D.	Hole Dia. F +3.2,-0 /+0.13,-0	Dimensions - mm/in					Bolt Size mm/in
			T†	A	B	C	D	
50x15	60.3x21.3	38	50	56	42	120	76	M10x60
2x1/2	2.375x0.825	1.50	1.97	2.20	1.65	4.72	2.99	3/8x2-3/8
50x20	60.3x26.7	38	50	56	42	120	76	M10x60
2x3/4	2.375x1.05	1.50	1.97	2.20	1.65	4.72	2.99	3/8x2-3/8
50x25	60.3x33.7	38	47	56	42	120	76	M10x60
2x1	2.375x1.327	1.50	1.85	2.20	1.65	4.72	2.99	3/8x2-3/8
50x32	60.3x42.4	44.5	52	68	42	120	84	M10x60
2x11/4	2.375x1.669	1.75	2.05	2.68	1.65	4.72	3.31	3/8x2-3/8
50x40	60.3x48.3	44.5	52	71	42	120	84	M10x60
2x11/2	2.375x1.9	1.75	2.05	2.80	1.65	4.72	3.31	3/8x2-3/8
65x15	73x21.3	38	56	61.5	47	143	76	M12x65
21/2x1/2	2.375x0.825	1.50	2.20	2.42	1.85	5.63	2.99	1/2x2-5/8
65x20	73x26.7	38	56	61.5	47	143	76	M12x65
21/2x3/4	2.875x1.05	1.50	2.20	2.42	1.85	5.63	2.99	1/2x2-5/8
65x25	73.0x33.7	38	53	61.5	47	143	76	M12x65
21/2x1	2.875x1.327	1.50	2.09	2.42	1.85	5.63	2.99	1/2x2-5/8
65x32	73.0x42.4	44.5	58	73.5	47	143	84	M12x65
21/2x11/4	2.875x1.669	1.75	2.28	2.89	1.85	5.63	3.31	1/2x2-5/8
65x40	73.0x48.3	50.8	58	73.5	47	143	90	M12x65
21/2x11/2	2.875x1.9	2.00	2.28	2.89	1.85	5.63	3.54	1/2x2-5/8
65x15	76.1x21.3	38	56	61.5	48	143	76	M12x65
21/2x1/2	3x0.825	1.50	2.20	2.42	1.89	5.63	2.99	1/2x2-5/8
65x20	76.1x26.7	38	56	61.5	48	143	76	M12x65
21/2x3/4	3x1.05	1.50	2.20	2.42	1.89	5.63	2.99	1/2x2-5/8
65x25	76.1x33.7	38	53	61.5	48	143	76	M12x65
21/2x1	3x1.327	1.50	2.09	2.42	1.89	5.63	2.99	1/2x2-5/8
65x32	76.1x42.4	44.5	58	73.5	48	143	84	M12x65
21/2x11/4	3x1.669	1.75	2.28	2.89	1.89	5.63	3.31	1/2x2-5/8
65x40	76.1x48.3	50.8	58	75	48	143	90	M12x65
21/2x11/2	3x1.9	2.00	2.28	2.95	1.89	5.63	3.54	1/2x2-5/8
80x15	88.9x21.3	38	64	69.5	55	158	76	M12x65
3x1/2	3.5x0.825	1.50	2.52	2.74	2.17	6.22	2.99	1/2x2-5/8
80x20	88.9x26.7	38	63	69.5	55	158	76	M12x65
3x3/4	3.5x1.05	1.50	2.48	2.74	2.17	6.22	2.99	1/2x2-5/8
80x25	88.9x33.7	38	61	69.5	55	158	76	M12x65
3x1	3.5x1.327	1.50	2.40	2.74	2.17	6.22	2.99	1/2x2-5/8
80x32	88.9x42.4	44.5	65	81	55	158	84	M12x65
3x11/4	3.5x1.669	1.75	2.56	3.19	2.17	6.22	3.31	1/2x2-5/8
80x40	88.9x48.3	50.8	71	81	55	158	90	M12x65
3x11/2	3.5x1.9	2.00	2.80	3.19	2.17	6.22	3.54	1/2x2-5/8
80x50	88.9x60.3	63.5	70	81	55	158	101	M12x65
3x2	3.5x2.375	2.50	2.76	3.19	2.17	6.22	3.98	1/2x2-5/8
100x25	108.1x33.7	38	73	76	62	167	76	M12x65
4x1	4.250x1.327	1.50	2.87	2.99	2.44	6.57	2.99	1/2x2-5/8
100x32	108.0x42.4	46	78	76	62	167	83	M12x65
4x11/4	4.25x1.669	1.81	3.07	2.99	2.44	6.57	3.27	1/2x2-5/8
100x40	108.0x48.3	53	83	76	62	167	90	M12x65
4x11/2	4.25x1.9	2.09	3.27	2.99	2.44	6.57	3.54	1/2x2-5/8
100x50	108.0x60.3	64	83	78	62	167	100	M12x65
4x2	4.25x2.375	2.52	3.27	3.07	2.44	6.57	3.94	1/2x2-5/8
100x65	108.0x76.1	80	73	105	62	167	117	M12x65
4x21/2	4.25x3	3.15	2.87	4.13	2.44	6.57	4.61	1/2x2-5/8
100x15	114.3x21.3	38	77	79	65	181	76	M12x70
4x1/2	4.5x0.825	1.50	3.03	3.11	2.56	7.13	2.99	1/2x2-3/4
100x20	114.3x26.7	38	76	79	65	181	76	M12x70
4x3/4	4.5x1.05	1.50	2.99	3.11	2.56	7.13	2.99	1/2x2-3/4
100x25	114.3x33.7	38	73	82	65	181	76	M12x70
4x1	4.5x1.327	1.50	2.87	3.23	2.56	7.13	2.99	1/2x2-3/4
100x32	114.3x42.4	44.5	78	94	65	181	84	M12x70
4x11/4	4.5x1.669	1.75	3.07	3.70	2.56	7.13	3.31	1/2x2-3/4
100x40	114.3x48.3	50.8	83	94	65	181	90	M12x70
4x11/2	4.5x1.9	2.00	3.27	3.70	2.56	7.13	3.54	1/2x2-3/4
100x50	114.3x60.3	63.5	83	94	65	181	101	M12x70
4x2	4.5x2.375	2.50	3.27	3.70	2.56	7.13	3.98	1/2x2-3/4
100x65	114.3x76.1	70	73	99	65	181	117	M12x70
4x21/2	4.5x3	2.76	2.87	3.90	2.56	7.13	4.61	1/2x2-3/4
100x80	114.3x88.9	89	84	100	65	181	136	M12x70
4x3	4.5x3.5	3.50	3.31	3.94	2.56	7.13	5.35	1/2x2-3/4
125x25	133.0x33.7	38	85	89	74	205	76	M12x75
5x1	5.250x1.327	1.50	3.35	3.50	2.91	8.07	2.99	1/2x3
125x32	133.0x42.4	46	90	89	74	205	83	M12x75
5x11/4	5.25x1.669	1.81	3.54	3.50	2.91	8.07	3.27	1/2x3
125x40	133.0x48.3	53	95	89	74	205	90	M12x75
5x11/2	5.25x1.9	2.09	3.74	3.50	2.91	8.07	3.54	1/2x3

Nominal Size mm/in	Pipe O.D.	Hole Dia. \pm +3.2,-0 /+0.13,-0	Dimensions - mm/in				Bolt Size mm/in	
			T \ddagger	A	B	C		D
125x50	133.0x60.3	64	95	89	74	205	100	M12x75
5x2	5.25x2.375	2.52	3.74	3.50	2.91	8.07	3.94	1/2x3
125x65	133.0x76.1	80	97	92	74	205	117	M12x75
5x2 1/2	5.25x3	3.15	3.82	3.62	2.91	8.07	4.61	1/2x3
125x80	133.0x88.9	92	106	94	74	205	129	M12x75
5x3	5.25x3.5	3.62	4.17	3.70	2.91	8.07	5.08	1/2x3
125x25	139.7x33.7	38	97	96.5	77	219	76	M16x85
5x1	5.5x1.327	1.50	3.82	3.80	3.03	8.62	2.99	5/8x3-1/3
125x32	139.7x42.4	44.5	97	107	77	219	84	M16x85
5x1 1/4	5.5x1.669	1.75	3.82	4.21	3.03	8.62	3.31	5/8x3-1/3
125x40	139.7x48.3	50.8	102	107	77	219	90	M16x85
5x1 1/2	5.5x1.9	2.00	4.02	4.21	3.03	8.62	3.54	5/8x3-1/3
125x50	139.7x60.3	63.5	102	108	77	219	101	M16x85
5x2	5.5x2.375	2.50	4.02	4.25	3.03	8.62	3.98	5/8x3-1/3
125x65	139.7x76.1	70	92	115	77	219	117	M16x85
5x2 1/2	5.5x3	2.76	3.62	4.53	3.03	8.62	4.61	5/8x3-1/3
125x80	139.7x88.9	89	97	118	77	219	136	M16x85
5x3	5.5x3.5	3.50	3.82	4.65	3.03	8.62	5.35	5/8x3-1/3
125x25	141.3x33.7	38	77	96.5	77	219	76	M16x85
5x1	5.563x1.327	1.50	3.03	3.80	3.03	8.62	2.99	5/8x3-1/3
125x32	141.3x42.4	44.5	77	107	77	219	84	M16x85
5x1 1/4	5.563x1.669	1.75	3.03	4.21	3.03	8.62	3.31	5/8x3-1/3
125x40	141.3x48.3	50.8	83	107	77	219	90	M16x85
5x1 1/2	5.563x1.9	2.00	3.27	4.21	3.03	8.62	3.54	5/8x3-1/3
125x50	141.3x60.3	63.5	83	108	77	219	101	M16x85
5x2	5.563x2.375	2.50	3.27	4.25	3.03	8.62	3.98	5/8x3-1/3
125x65	141.3x76.1	70	93	115	77	219	117	M16x85
5x2 1/2	5.563x3	2.76	3.66	4.53	3.03	8.62	4.61	5/8x3-1/3
125x80	141.3x88.9	89	97	118	77	219	136	M16x85
5x3	5.563x3.5	3.50	3.82	4.65	3.03	8.62	5.35	5/8x3-1/3
150x25	159x33.7	38	113	101.5	91	233	76	M14x75
6x1	6.250x1.327	1.50	4.45	4.00	3.58	9.17	2.99	9/16x3
150x32	159.0x42.4	46	113	101.5	91	233	83	M14x75
6x1 1/4	6.250x1.669	1.81	4.45	4.00	3.58	9.17	3.27	9/16x3
150x40	159.0x48.3	53	112	101.5	91	233	90	M14x75
6x1 1/2	6.250x1.9	2.09	4.41	4.00	3.58	9.17	3.54	9/16x3
150x50	159.0x60.3	64	111	101.5	91	233	100	M14x75
6x2	6.250x2.375	2.52	4.37	4.00	3.58	9.17	3.94	9/16x3
150x65	159.0x76.1	80	111	105.5	91	233	117	M16x85
6x2 1/2	6.250x3	3.15	4.37	4.15	3.58	9.17	4.61	5/8x3-1/3
150x80	159.0x88.9	92	110	105.5	91	233	129	M16x85
6x3	6.250x3.5	3.62	4.33	4.15	3.58	9.17	5.08	5/8x3-1/3
150x100	159.0x114.3	118	96.8	110	91	233	157	M16x85
6x4	6.250x4.5	4.65	3.81	4.33	3.58	9.17	6.18	5/8x3-1/3
150x25	165.1x33.7	38	99	108.5	94	248	76	M16x85
6x1	6.5x1.327	1.50	3.90	4.27	3.7	9.76	2.99	5/8x3-1/3
150x32	165.1x42.4	44.5	112	120	94	248	84	M16x85
6x1 1/4	6.5x1.669	1.75	4.41	4.72	3.7	9.76	3.31	5/8x3-1/3
150x40	165.1x48.3	50.8	112	120	94	248	90	M16x85
6x1 1/2	6.5x1.9	2.00	4.41	4.72	3.7	9.76	3.54	5/8x3-1/3
150x50	165.1x60.3	63.5	111	121	94	248	101	M16x85
6x2	6.5x2.375	2.50	4.37	4.76	3.7	9.76	3.98	5/8x3-1/3
150x65	165.1x76.1	70	110	126.5	94	248	117	M16x85
6x2 1/2	6.5x3	2.76	4.33	4.98	3.7	9.76	4.61	5/8x3-1/3
150x80	165.1x88.9	89	110	129.5	94	248	136	M16x85
6x3	6.5x3.5	3.50	4.33	5.10	3.7	9.76	5.35	5/8x3-1/3
150x100	165.1x114.3	114	97	136	94	248	162	M16x85
6x4	6.5x4.5	4.49	3.82	5.35	3.7	9.76	6.38	5/8x3-1/3
150x25	168.3x33.7	38	112	108.5	97	248	76	M16x85
6x1	6.625x1.327	1.50	4.41	4.27	3.82	9.76	2.99	5/8x3-1/3
150x32	168.3x42.4	44.5	112	120	97	248	84	M16x85
6x1 1/4	6.625x1.669	1.75	4.41	4.72	3.82	9.76	3.31	5/8x3-1/3
150x40	168.3x48.3	50.8	112	120	97	248	90	M16x85
6x1 1/2	6.625x1.9	2.00	4.41	4.72	3.82	9.76	3.54	5/8x3-1/3
150x50	168.3x60.3	63.5	111	121	97	248	101	M16x85
6x2	6.625x2.375	2.50	4.37	4.76	3.82	9.76	3.98	5/8x3-1/3
150x65	168.3x76.1	70	110	128	97	248	117	M16x85
6x2 1/2	6.625x3	2.76	4.33	5.04	3.82	9.76	4.61	5/8x3-1/3
150x80	168.3x88.9	89	110	131	97	248	136	M16x85
6x3	6.625x3.5	3.50	4.33	5.16	3.82	9.76	5.35	5/8x3-1/3
150x100	168.3x114.3	114	97	139.5	97	248	162	M16x85
6x4	6.625x4.5	4.49	3.82	5.49	3.82	9.76	6.38	5/8x3-1/3
200x25	219.1x33.7	38	152	136	125	322	76	M20x90
8x1	8.625x1.327	1.50	5.98	5.35	1.92	12.68	2.99	5/8x3-1/2
200x32	219.1x42.4	44.5	152	147	125	322	84	M20x90
8x1 1/4	8.625x1.669	1.75	5.98	5.79	1.92	12.68	3.31	5/8x3-1/2
200x40	219.1x48.3	50.8	152	147	125	322	90	M20x90
8x1 1/2	8.625x1.9	2.00	5.98	5.79	1.92	12.68	3.54	5/8x3-1/2
200x50	219.1x60.3	63.5	138	147	125	322	101	M20x90
8x2	8.625x2.375	2.50	5.43	5.79	1.92	12.68	3.98	5/8x3-1/2
200x65	219.1x76.1	70	129	156	125	322	117	M20x90
8x2 1/2	8.625x3	2.76	5.08	6.14	1.92	12.68	4.61	5/8x3-1/2
200x80	219.1x88.9	89	135	158.5	125	322	136	M20x90
8x3	8.625x3.5	3.50	5.31	6.24	1.92	12.68	5.35	5/8x3-1/2
200x100	219.1x114.3	114	122	167	125	322	162	M20x90
8x4	8.625x4.5	4.49	4.80	6.57	1.92	12.68	6.38	5/8x3-1/2

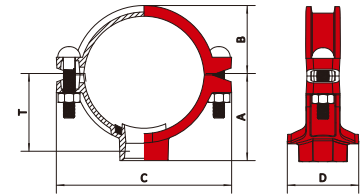

MODEL XGQT04G MECHANICAL TEE GROOVED OUTLET

The Model XGQT04G Mechanical Tee provides a fast and easy mid-pipe grooved branch outlet. The mechanical tee utilizes ductile iron housings, a grade E gasket and heat-treated carbon steel track bolts and nuts. Housing are

painted orange or red, or as an option can be supplied hot-dipped zinc galvanized or epoxy coated. Maximum working pressure: 300 psi (20 bar).

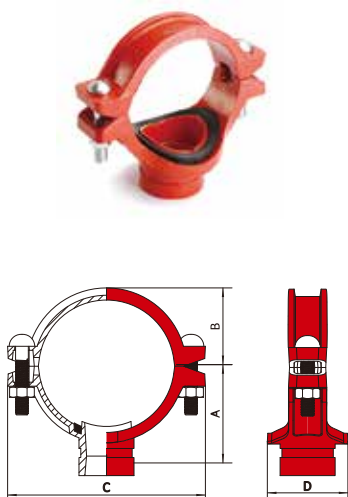

Nominal Size mm/in	Pipe O.D.	Hole Dia. \mp +3.2,-0 /+0.13,-0	Dimensions - mm/in				Bolt Size mm/in
			A	B	C	D	
50x25	60.3x33.7	38	72	42	120	76	M10x60
2x1	2.375x1.327	1.50	2.83	1.65	4.72	2.99	3/8x2-3/8
50x32	60.3x42.4	44.5	72.5	42	120	84	M10x60
2x1 1/4	2.375x1.669	1.75	2.85	1.65	4.72	3.31	3/8x2-3/8
50x40	60.3x48.3	44.5	72.5	42	120	84	M10x60
2x1 1/2	2.375x1.9	1.75	2.85	1.65	4.72	3.31	3/8x2-3/8
65x25	73x33.7	38	78	47	143	76	M12x65
2 1/2x1	2.875x1.327	1.50	3.07	1.85	5.63	2.99	1/2x2-5/8
65x32	73x42.4	44.5	78.5	47	143	84	M12x65
2 1/2x1 1/4	2.875x1.669	1.75	3.09	1.85	5.63	3.31	1/2x2-5/8
65x40	73x48.3	50.8	78.5	47	143	90	M12x65
2 1/2x1 1/2	2.875x1.9	2.00	3.09	1.85	5.63	3.54	1/2x2-5/8
65x25	76.1x33.7	38	79.5	48	143	76	M12x65
2 1/2x1	3x1.327	1.50	3.13	1.89	5.63	2.99	1/2x2-5/8
65x32	76.1x42.4	44.5	80	48	143	84	M12x65
2 1/2x1 1/4	3x1.669	1.75	3.15	1.89	5.63	3.31	1/2x2-5/8
65x40	76.1x48.3	50.8	80	48	143	90	M12x65
2 1/2x1 1/2	3x1.9	2.00	3.15	1.89	5.63	3.54	1/2x2-5/8
80x25	88.9x33.7	38	85.5	55	158	76	M12x65
3x1	3.5x1.327	1.50	3.37	2.17	6.22	2.99	1/2x2-5/8
80x32	88.9x42.4	44.5	86	55	158	84	M12x65
3x1 1/4	3.5x1.669	1.75	3.39	2.17	6.22	3.31	1/2x2-5/8
80x40	88.9x48.3	50.8	86	55	158	90	M12x65
3x1 1/2	3.5x1.9	2.00	3.39	2.17	6.22	3.54	1/2x2-5/8
80x50	88.9x60.3	63.5	87	55	158	101	M12x65
3x2	3.5x2.375	2.50	3.43	2.17	6.22	3.98	1/2x2-5/8
100x50	108x60.3	64	92.5	62	172	90	M12x65
4x2	4.25x2.375	2.52	3.64	2.44	6.77	3.54	1/2x2-5/8
100x65	108x76.1	80	92.5	62	172	107	M12x65
4x2 1/2	4.25x3	3.15	3.64	2.44	6.77	4.21	1/2x2-5/8
100x25	114.3x33.7	38	98	65	181	76	M12x70
4x1	4.5x1.327	1.50	3.86	2.56	7.13	2.99	1/2x2-3/4
100x32	114.3x42.4	44.5	99	65	181	84	M12x70
4x1 1/4	4.5x1.669	1.75	3.90	2.56	7.13	3.31	1/2x2-3/4
100x40	114.3x48.3	50.8	99	65	181	90	M12x70
4x1 1/2	4.5x1.9	2.00	3.90	2.56	7.13	3.54	1/2x2-3/4
100x50	114.3x60.3	63.5	99	65	181	101	M12x70
4x2	4.5x2.375	2.50	3.90	2.56	7.13	3.98	1/2x2-3/4
100x65	114.3x73	70	99	65	181	117	M12x70
4x2 1/2	4.5x2.875	2.76	3.90	2.56	7.13	4.61	1/2x2-3/4
100x65	114.3x76.1	70	99	65	181	117	M12x70
4x2 1/2	4.5x3	2.76	3.90	2.56	7.13	4.61	1/2x2-3/4
100x80	114.3x88.9	89	99	65	181	136	M12x70
4x3	4.5x3.5	3.50	3.90	2.56	7.13	5.35	1/2x2-3/4
125x40	133x48.3	53	105.5	74	205	90	M12x75
5x1 1/2	5.25x1.9	2.09	4.15	2.91	8.07	3.54	1/2x3
125x50	133x60.3	64	105.5	74	205	100	M12x75
5x2	5.25x2.375	2.52	4.15	2.91	8.07	3.94	1/2x3
125x65	133x76.1	80	105.5	74	205	117	M12x75
5x2 1/2	5.25x3	3.15	4.15	2.91	8.07	4.61	1/2x3
125x80	133x88.9	92	105.5	74	205	129	M12x75
5x3	5.25x3.5	3.62	4.15	2.91	8.07	5.08	1/2x3
125x32	139.7x42.4	44.5	112	77	219	84	M16x85
5x1 1/4	5.5x1.669	1.75	4.41	3.03	8.62	3.31	5/8x3-1/3
125x40	139.7x48.3	50.8	112	77	219	90	M16x85
5x1 1/2	5.5x1.9	2.00	4.41	3.03	8.62	3.54	5/8x3-1/3
125x50	139.7x60.3	63.5	113	77	219	101	M16x85
5x2	5.5x2.375	2.50	4.45	3.03	8.62	3.98	5/8x3-1/3
125x65	139.7x73	70	113	77	219	117	M16x85
5x2 1/2	5.5x2.875	2.76	4.45	3.03	8.62	4.61	5/8x3-1/3
125x65	139.7x76.1	70	113	77	219	117	M16x85
5x2 1/2	5.5x3	2.76	4.45	3.03	8.62	4.61	5/8x3-1/3
125x80	139.7x88.9	89	113	77	219	136	M16x85
5x3	5.5x3.5	3.50	4.45	3.03	8.62	5.35	5/8x3-1/3

MODEL XGQT04G MECHANICAL TEE GROOVED OUTLET

The Model XGQT04G Mechanical Tee provides a fast and easy mid-pipe grooved branch outlet. The mechanical tee utilizes ductile iron housings, a grade E gasket and heat-treated carbon steel track bolts and nuts. Housing are

painted orange or red, or as an option can be supplied hot-dipped zinc galvanized or epoxy coated. Maximum working pressure: 300 psi (20 bar). Gaskets are interchangeable between Models 7721 and 7722.

Nominal Size mm/in	Pipe O.D.	Hole Dia. \pm $+3.2, -0$ $/+0.13, -0$	Dimensions - mm/in				Bolt Size mm/in
			A	B	C	D	
125x40	141.3x42.4	44.5	112	77	219	84	M16x85
5x11/2	5.563x1.669	1.75	4.41	3.03	8.62	3.31	5/8x3-1/3
125x40	141.3x48.3	50.8	112	77	219	90	M16x85
5x11/2	5.563x1.9	2.00	4.41	3.03	8.62	3.54	5/8x3-1/3
125x50	141.3x60.3	63.5	113	77	219	101	M16x85
5x2	5.563x2.375	2.50	4.45	3.03	8.62	3.98	5/8x3-1/3
125x65	141.3x73	70	113	77	219	117	M16x85
5x21/2	5.563x2.875	2.76	4.45	3.03	8.62	4.61	5/8x3-1/3
125x65	141.3x76.1	70	113	77	219	117	M16x85
5x21/2	5.563x3	2.76	4.45	3.03	8.62	4.61	5/8x3-1/3
125x80	141.3x88.9	89	113	77	219	136	M16x85
5x3	5.563x3.5	3.50	4.45	3.03	8.62	5.35	5/8x3-1/3
150x50	159x60.3	64	118	91	233	100	M14x75
6x2	6.25x2.375	2.52	4.65	3.58	9.17	3.94	9/16x3
150x65	159x76.1	80	118	91	233	117	M14x75
6x21/2	6.25x3	3.15	4.65	3.58	9.17	4.61	9/16x3
150x80	159x88.9	92	118	91	233	129	M14x75
6x3	6.25x3.5	3.62	4.65	3.58	9.17	5.08	9/16x3
150x100	159.0x108.0	104	119.5	91	233	143	M14x75
6x4	6.25x4.25	4.09	4.70	3.58	9.17	5.63	9/16x3
150x100	159.0x114.3	111	119.5	91	233	153	M14x75
6x4	6.25x4.5	4.37	4.70	3.58	9.17	6.02	9/16x3
150x32	165.1x42.4	44.5	125	94	248	84	M16x85
6x11/4	6.5x1.669	1.75	4.92	3.7	9.76	3.31	5/8x3-1/3
150x40	165.1x48.3	50.8	125	94	248	90	M16x85
6x11/2	6.5x1.9	2.00	4.92	3.7	9.76	3.54	5/8x3-1/3
150x50	165.1x60.3	63.5	125	94	248	101	M16x85
6x2	6.5x2.375	2.50	4.92	3.7	9.76	3.98	5/8x3-1/3
150x65	165.1x73	70	125	94	248	117	M16x85
6x21/2	6.5x2.875	2.76	4.92	3.7	9.76	4.61	5/8x3-1/3
150x65	165.1x76.1	70	125	94	248	117	M16x85
6x21/2	6.5x3	2.76	4.92	3.7	9.76	4.61	5/8x3-1/3
150x80	165.1x88.9	89	125	94	248	136	M16x85
6x3	6.5x3.5	3.50	4.92	3.7	9.76	5.35	5/8x3-1/3
150x100	165.1x108	114	129	94	248	162	M16x85
6x4	6.5x4.25	4.49	5.08	3.7	9.76	6.38	5/8x3-1/3
150x100	165.1x114.3	114	129	94	248	162	M16x85
6x4	6.5x4.5	4.49	5.08	3.7	9.76	6.38	5/8x3-1/3
150x32	168.3x42.4	44.5	125	97	248	84	M16x85
6x11/4	6.625x1.669	1.75	4.92	3.82	9.76	3.31	5/8x3-1/3
150x40	168.3x48.3	50.8	125	97	248	90	M16x85
6x11/2	6.625x1.9	2.00	4.92	3.82	9.76	3.54	5/8x3-1/3
150x50	168.3x60.3	63.5	125	97	248	101	M16x85
6x2	6.625x2.375	2.50	4.92	3.82	9.76	3.98	5/8x3-1/3
150x65	168.3x73	70	127	97	248	117	M16x85
6x21/2	6.625x2.875	2.76	5.00	3.82	9.76	4.61	5/8x3-1/3
150x65	168.3x76.1	70	127	97	248	117	M16x85
6x21/2	6.625x3	2.76	5.00	3.82	9.76	4.61	5/8x3-1/3
150x80	168.3x88.9	89	127	97	248	136	M16x85
6x3	6.625x3.5	3.50	5.00	3.82	9.76	5.35	5/8x3-1/3
150x100	168.3x114.3	114	129	97	248	162	M16x85
6x4	6.625x4.5	4.49	5.08	3.82	9.76	6.38	5/8x3-1/3
200x50	219.1x60.3	63.5	152	125	322	101	M20x90
8x2	8.625x2.375	2.50	5.98	1.92	12.68	3.98	5/8x3-1/2
200x65	219.1x73	70	154	125	322	117	M20x90
8x21/2	8.625x2.875	2.76	6.06	1.92	12.68	4.61	5/8x3-1/2
200x65	219.1x76.1	70	154	125	322	117	M20x90
8x21/2	8.625x3	2.76	6.06	1.92	12.68	4.61	5/8x3-1/2
200x80	219.1x88.9	89	154	125	322	136	M20x90
8x3	8.625x3.5	3.50	6.06	1.92	12.68	5.35	5/8x3-1/2
200x100	219.1x108	114	156	125	322	162	M20x90
8x4	8.625x4.25	4.49	6.14	1.92	12.68	6.38	5/8x3-1/2
200x100	219.1x114.3	114	156	125	322	162	M20x90
8x4	8.625x4.5	4.49	6.14	1.92	12.68	6.38	5/8x3-1/2

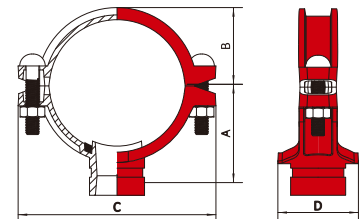

MODEL J01 FEMALE THREADED OUTLET FITTING

The Model J01 outlet fittings are designed to provide you with a threaded outlet at any desired location along the header. Made of highly weldable SAE J403 forged steel the Model J01 is designed for single pass welding. The precision machined mouth is designed to fit the first listed header size perfectly, and allows only a small gap along the longitudinal centerline of the second listed header size. The Model J01 features a counter bore (dim. C) and a 1.6mm land around the full circumference of the mouth, which helps ensure full penetration welds and minimize the likelihood of any burn through or distortion that might be caused by excessive heat. The Model J01 is UL / cUL listed and FM approved for service up to 300 psi (20 bar).

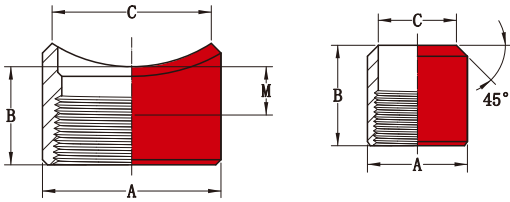

The hole cut in the header pipe can be cut prior to or subsequent to welding of the fitting. If holes are cut prior to welding, as some codes require, follow the recommended welding procedures to avoid shrinkage and/or distortion of the header pipe.

Caution: Excessive heat may cause the threads to distort and or leak. When holes are cut after welding, the pipe remains intact and thus may reduce shrinkage or pipe distortion.

Outlet Size mm/in	Header Size Range in	Outlet OD A mm/in	Outlet Length B mm/in	Counter-bore C mm/in	Make-Up M mm/in	Weight Kgs/Lbs					
8 0.25	Flat	19.1	31.8	10.7	18.0	0.05					
		0.750	1.250	0.421	0.789	0.11					
15 0.5	1-1/2-2	27.8	25.4	23.1	12.7	0.08					
	2-2-1/2										
	2-1/2-8						1.094	1.000	0.91	0.500	0.17
20 0.75	1-1/4-1-1/2	34.9	28.6	22.9	12.7	0.12					
	1-1/2-2										
	2-2-1/2						1.375	1.125	0.900	0.500	0.26
	2-1/2-8										
25 1	1-1/4-1-1/2	39.5	28.60	34.4	12.7	0.13					
	1-1/2-2										
	2-2-1/2						1.555	1.126	1.354	0.500	0.29
	2-1/2-3										
	3-4										
5-8											
32 1.25	1-1/4-1-1/2	47.5	31.8	44.0	12.7	0.19					
	1-1/2-2										
	2-2-1/2						1.870	1.252	1.732	0.500	0.42
	2-1/2-3										
	3-4										
5-8											
40 1.5	1-1/2	55.0	31.8	49.8	22.2	0.22					
	2										
	2-1/2						2.165	1.252	1.961	0.875	0.47
	3-4										
	4										
5-8											
50 2	2	69.3	38.1	61.8	22.2	0.38					
	2.5										
	3						2.728	1.500	2.433	0.875	0.57
	4										
	5										
	6										
8											
65 2.5 (73.00D)	2-1/2	80.4	54.0	62.7	28.6	0.55					
	3										
	4						3.165	2.215	2.469	1.125	1.15
	5										
	6										
8											
65 2.5 (76.10D)	2.5	83.5	54.0	62.7	28.6	0.55					
	3										
	4						3.290	2.215	2.469	1.125	1.15
	5										
	6										
8											
80 3	3	98.0	63.5	77.9	38.1	0.77					
	4										
	5						3.861	2.500	3.068	1.500	1.70
	6										
100 4	8	125.2	76.2	102.3	50.8	1.32					
	4										
	5						4.933	3.000	4.026	2.000	2.80
	6										
	8										

MODEL J02R CUT GROOVED OUTLET FITTING

The Model J02R outlet fittings are designed to provide you with a cut grooved outlet at any desired location along the header. Made from ASTM A106 Sch. 40 pipe, the J02R features cut grooves to AWWA C606 and 1.6mm lands around the full circumference of the mouth. UL/cUL listed and FM approved to 300 psi (20 bar).

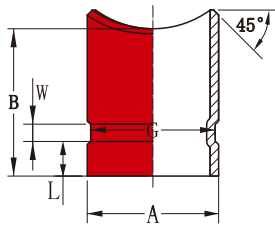

Outlet Size mm/in	Run Pipe in	Dimensions					Weight Kgs/Lbs
		A mm/in	B mm/in	L mm/in	W mm/in	G mm/in	
50 2	2	60.3	76.2	15.88	7.95	57.15	0.45
	2.5						
	3						
	4						
	5						
65 2-1/2	6-8	2.375	3.000	0.625	0.312	2.250	1.00
	2.5						
	4						
80 3	5	73.0	76.2	15.88	7.95	69.09	0.73
	6-8						
	2.5						
100 4	4	88.9	76.2	15.88	7.95	84.94	0.91
	5						
	6-8						
150 6	6-8	3.500	3.000	0.625	0.312	3.346	2.00
	4						
	5						
200 8	4	114.3	101.6	15.88	9.53	110.08	1.73
	5						
	6-8						
150 6	6	168.3	101.6	15.88	9.53	163.96	3.18
	8						
	6.625						
200 8	8	219.1	101.6	19.05	11.13	214.40	4.32
	10						
	8.625						

MODEL J02R ROLL GROOVED OUTLET FITTING

The Model J02R outlet fittings is designed to provide you with a roll grooved outlet at any desired location along the header. Made from ASTM A53 or equivalent Sch. 10 pipe, the J02R features roll grooves to AWWA C606, ideal for use with light wall pipe. The Model J02R minimizes the likelihood of burn through or distortion. UL/cUL listed and FM approved to 300 psi (20 bar).

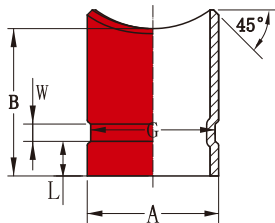

Outlet Size mm/in	Run Pipe in	Dimensions					Weight Kgs/Lbs
		A mm/in	B mm/in	L mm/in	W mm/in	G mm/in	
32 1.25	1.25-1.5	42.2	63.5	15.88	7.14	38.99	0.21
	2						
	2.5						
	3						
	4						
	5						
40 1.25	6-8	1.660	2.500	0.625	0.281	1.535	1.46
	1.5						
	2						
	2.5						
	3						
	4						
50 2	5	48.3	63.5	15.88	7.14	45.09	0.24
	6-8						
	2						
	2.5						
	3						
	4						
65 2.5 (73.0OD)	5	1.900	2.500	0.625	0.281	1.775	0.53
	6-8						
	2						
	2.5						
	3						
	4						
65 2.5 (76.0OD)	5	60.3	76.2	15.88	8.74	57.15	0.41
	6-8						
	2						
	2.5						
	3						
	4						
80 3	5	2.375	3.000	0.625	0.344	2.250	0.90
	6-8						
	2.5						
	3						
	4						
	5						
100 4	6-8	73.0	76.2	15.88	8.74	69.09	0.64
	2.5						
	3						
	4						
	5						
	6-8						
100 4	2-1/2	76.1	76.2	15.88	8.74	72.26	0.64
	3						
	4						
	5						
	6-8						
	2.5						
150 6	3	3.000	3.000	0.625	0.344	2.845	1.41
	4						
	5						
	6-8						
	3						
	4						
200 8	5	88.9	76.2	15.88	8.74	84.94	0.77
	6-8						
	3						
	4						
	5						
	6-8						
200 8	4	114.3	101.6	15.88	8.74	110.08	1.45
	5						
	6-8						
	3						
	4						
	5						
200 8	6-8	4.500	4.000	0.625	0.344	4.314	3.19
	4						
	5						
	6-8						
	3						
	4						

MODEL 500 EXPANSION JOINT

The Model 500 Expansion Joint is a slide-type expansion joint which provides 0 to 3" (0 to 76mm) of axial end movement. The components are supplied epoxy coated (RAL3000 red) for easier use and longer life. An integral safety device prevents excess movement and or the accidental pull-out of the grooved end pieces.

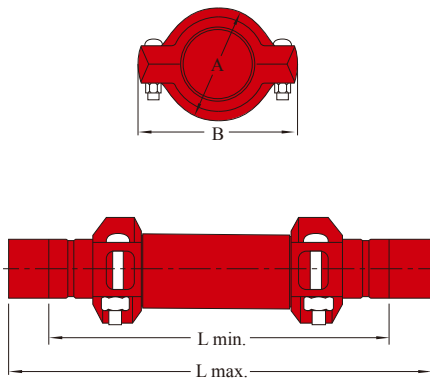

Nominal Size mm/in	Pipe O.D. mm/in	Max. Working Pressure Bar/PSI	Max. Movement mm/in	Dimensions				Weight Kgs/Lbs
				A mm/in	B mm/in	L min. mm/in	L max. mm/in	
50	60.3	25	76	96	144	304	381	7.2
2	2.375	350	3	3.78	5.67	12.00	15.00	15.8
65	73.0	25	76	116	168	304	381	9.6
2.5	2.875	350	3	4.57	6.61	12.00	15.00	21.1
65	76.1	25	76	116	168	304	381	9.6
2.5	3.000	350	3	4.57	6.61	12.00	15.00	21.1
80	88.9	25	76	146	198	304	381	12.5
3	3.500	350	3	5.76	7.80	12.00	15.00	27.5
100	114.3	25	76	160	250	359	435	18.0
4	4.500	350	3	6.30	9.84	14.13	17.13	39.6
150	165.1	25	76	260	334	406	482	34.0
6	6.500	350	3	10.25	13.15	16.00	19.00	74.8
150	168.3	25	76	260	334	406	482	34.0
6	6.625	350	3	10.25	13.15	16.00	19.00	74.8

MODEL 501 EXPANSION JOINT

The Model 501 Expansion Joint is a combination of couplings and specially machined pipe nipples that are joined in a series to accommodate the expansion and or contraction of a piping system. Standard units are comprised of either Model XGQT2 or Model 1212 flexible couplings and cut- grooved Sch. 40 pipe nipples. Customized units are available.

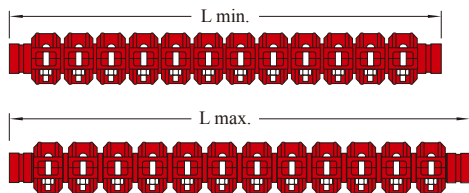

Nominal Size mm/in	Pipe O.D. mm/in	Max. Movement mm/in	L min. mm/in	L max. mm/in	Weight Kgs/Lbs
40	48.3	58	718	776	11.0
1.5	1.900	2.25	28.25	30.13	24.2
50	60.3	58	718	776	12.2
2	2.375	2.25	28.25	30.13	27.0
65	73.0	58	718	776	16.3
2.5	2.875	2.25	28.25	30.13	36.0
65	76.1	58	718	776	16.3
2.5	3.000	2.25	28.25	30.13	36.0
80	88.9	58	718	776	20.9
3	3.500	2.25	28.25	30.13	46.0
100	114.3	45	667	712	24.5
4	4.500	1.75	26.25	28.00	54.0
125	133.0	45	667	712	32.7
5	5.250	1.75	26.25	28.00	72.0
150	165.1	45	667	712	32.7
6	6.500	1.75	26.25	28.00	72.0
150	168.3	45	667	712	40.8
6	6.625	1.75	26.25	28.00	90.0
200	219.1	45	724	769	68.0
8	8.625	1.75	28.50	30.25	150.0

SPECIFICATIONS

We offers a wide range of grooved-end fittings in size through 24" (600mm). Fittings are available in a number of styles and configurations to support a variety of applications. Lede grooved-end fittings are designed to meet the ASTM F1548-01 and ANSI/AWWA C606-04 requirements. For other pipe size not specified in these standards, refer to applicable groove specifications shown in this catalog. Most fittings are provided in ductile iron conforming to ASTM A536 Gr. 65-45-12. Some styles and size are fabricated of segmentally welded steel. Fittings are painted orange or red, or as an option can be supplied hot-dip galvanized or epoxy coated. Pressure ratings conform to couplings and/or pipe being used.



MODEL MD GROOVE RULE

The grooved diameter rule is a simple and easy to use steel tape rule used for taking circumferential measurements. The Model MD rules are designed to accurately measure the standard groove dimensions of pipe and are available for measuring, sizes 25mm through 1050mm (1" - 42"). The double sided direct reading diameter rule features two scales and a quick check reference which indicates the acceptable groove range for all pipe sizes.

MD20: 200cmL x 6mmW -for 25mm-1050mm (1" - 42") pipe



SELF LUBRICANT

All EPDM gaskets are self-lubricant, it allows the gaskets to be installed on the pipe without sparying lubricant. for other gaskets except EPDM, like silicon gasket, lubricant is recommended and to help prevent the gasket from being pinched. The lubricant is applied in a thin coat to the gasket exterior, the gasket lips and/or the housing interiors.



TYPICAL APPLICATIONS - FLEXIBLE COUPLINGS - GENERAL SYSTEMS -

1. Absorption of vibration and noise

When a pump operates with frequent starts and stops, the piping system is affected by the noise and vibration of the equipment. The entire system may develop a large sway, referred to as sympathetic vibration, as a result of the frequent cycling. Lede flexible couplings will help reduce such vibration and noise. The system should always be properly designed with steel angle sway braces to protect the system from large sways.

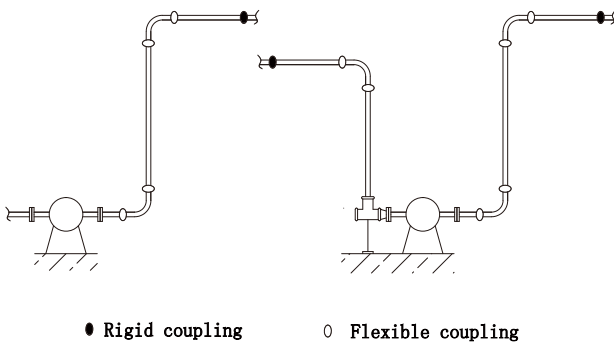

2. Adjustment of misalignment

When a straight run has need for a slight adjustment of alignment on the jobsite as shown in the diagram, you can accomplish this with the use of two flexible couplings. The following table shows the deflection value (θ) of the Lede 7705 flexible couplings.

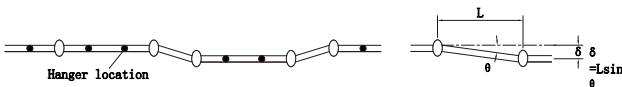

Amount of deflection (δ)						
Nominal Size	Deflection Angle (θ)	Distance between couplings (L) mm				
		600	1200	1500	2000	3000
2"/50	3° 02'	32	64	79	106	159
2 1/2"/65	2° 30'	26	52	65	87	131
3"/80	2° 04'	22	43	54	72	108
4"/100	3° 12'	34	67	84	112	168
5"/125	2° 36'	27	54	68	91	136
6"/150	1° 10'	12	24	31	41	61
8"/200	1° 40'	17	35	44	58	87
10"/250	1° 20'	14	28	35	47	70
12"/300	1° 08'	12	24	30	40	59

3. Absorption of distortion

With the use of an assembly as shown below, ground sinking or movement around a tank or reservoir can be effectively absorbed, avoiding damage to the tank, reservoir and or the piping system.

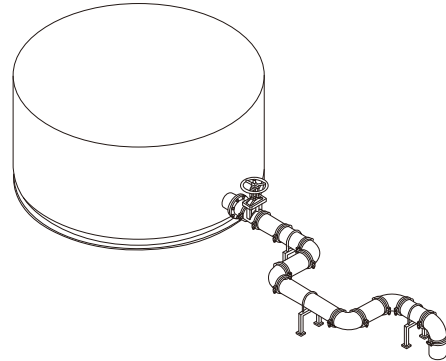

4. Absorption of inter-floor deflection

Risers of high-rise flexible structure buildings are subjected to lateral sways (inter-floor deflection) when an earthquake occurs. If we assume the inter-floor deflection (α) as 1/150 and the floor height (H) as 4 meters, the estimated inter-floor deflection (α) will be.

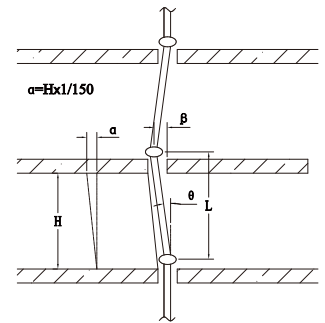

$$\alpha = H \times 1/150 = 4000 \times 1/150 = 27\text{mm}$$

If we use a 200mm (8") 7707 coupling for each floor, the maximum deflection (β) that each coupling can accommodate will be.

$$\beta = L \times \tan \theta = 4000 \times 0.02915 = 4.56'' = 116\text{mm} (\theta = 1.67^\circ)$$

The example shows a flexible coupling would be sufficient enough to absorb this scale of seismic sways.

5. Absorption of misalignment

As shown in the diagram, each branch connection to the free riser will be subjected to serious shearing forces as pressure thermal movement increases. By using two flexible couplings, you can solve this problem.

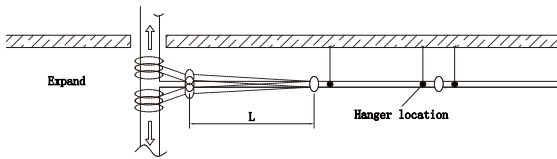

6. Curved layout

With Lede flexible couplings you can design a slowly curved layout for a system along a curved tunnel, winding road or curved building.

$$R = \frac{L}{(2 \times \tan \theta/2)}$$

(where: R is radius of curvature, L is pipe length, and θ is max. allowed deflection of a coupling)

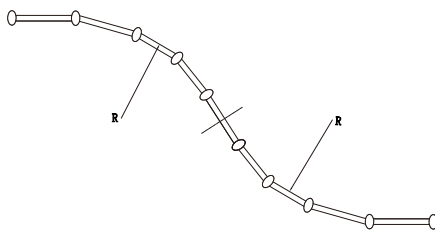

Example: When using model 7705 100mm (4") couplings for the layout as shown in the diagram, the max. allowed deflection (θ) of the coupling is 3.4°, and the pipe length (L) is 5.5 meters, the radius of curvature (R) will be 92.7 meters.

7. Absorption of Thermal Stress

Thermal stress is caused by changes in temperature, resulting in either expansion or contraction. With the use of Lede flexible couplings you can design your system to accommodate such movement without the need for costly expansion joints. The thermal expansion or contraction (μ) is determined by the length of pipe (L) and temperature difference (ΔT).

$$\mu = \alpha \times L \times \Delta T$$

Thermal Expansion (Metric)						
Temperature Difference ΔT (C)	Pipe Length L (meters)					
	1	5.5*	10	20	30	40
Thermal Expansion (millimeters)						
1	0.012	0.07	0.12	0.24	0.36	0.48
5	0.06	0.33	0.6	1.2	1.8	2.4
10	0.12	0.66	1.2	2.4	3.6	4.8
20	0.24	1.3	2.4	4.8	7.2	9.6
30	0.36	2	3.6	7.2	11	15
40	0.48	2.6	4.8	9.6	14	20
50	0.6	3.3	6	12	18	24
60	0.72	4	7.2	14	22	29
70	0.84	4.6	8.4	17	25	34
80	0.96	5.3	9.6	19	29	39

* 5.5 meters is the standard length of commercial carbon steel pipe.

As the liner expansion coefficient for steel (α) is 1.2×10^{-5} , you can use table above to determine the thermal expansion.

Example:

- Pipe size: 100mm (4")
- Max. pipe end separation (E): 3.2mm
- Pipe length (L): 5.5M
- Temperature difference (ΔT): 40°C (+5°C to +45°C)

$$\mu = \alpha \times L \times \Delta T = 1.2 \times 10^{-5} \times 5500 \times 40 = 2.64\text{mm}$$

The thermal expansion of a 5.5 meter standard length or pipe (μ) is within the allowance (= max. pipe end separation) of a flexible coupling. In other words, if you use a coupling for each pipe length of 5.5 meters, the coupling will accommodate the thermal expansion or contraction expected to take place for a 40°C temperature change. When you calculate the necessary number of coupling (N) for an anchored system, you should place a clearance of $N \times E \times 1/2$ as a safety factor.

Whether it is thermal expansion, contraction, or a combination thereof, the system requires suitable anchor installations with properly space alignment guides and weight support devices. Where and when larger thermal movement is anticipated, you should use supplementary expansion joint(s).

For installers who use the imperial units of measure, the following table will be more convenient.

Thermal Expansion (Imperial)				
Temp (°F)	Pipe Length L (feet)			
	20	40	60	100
Thermal Expansion between 70°F and indicated temperature (inch)				
0	-0.10	-0.20	-0.29	-0.49
25	-0.06	-0.13	-0.19	-0.32
50	-0.03	-0.06	-0.08	-0.14
70	0	0	0	0
100	0.05	0.09	0.14	0.23
125	0.08	0.17	0.25	0.42
150	0.12	0.24	0.37	0.61
175	0.16	0.32	0.48	0.80
200	0.20	0.40	0.59	0.99
225	0.24	0.48	0.73	1.21

* Coefficient of thermal expansion of steel pipe = 6.33 in/in, °F x 10^{-6}

TYPICAL APPLICATIONS - FLEXIBLE COUPLINGS - SPRINKLER SYSTEMS (NFPA 13)

The following illustrations are part of NFPA 13- 2007 Annex A Explanatory Material. These are for informational purposes only and not a mandatory requirement. For specific requirements for any other areas of sprinkler systems, refer to the latest version of NFPA 13.

1. Flexible couplings for main risers and branch line riser

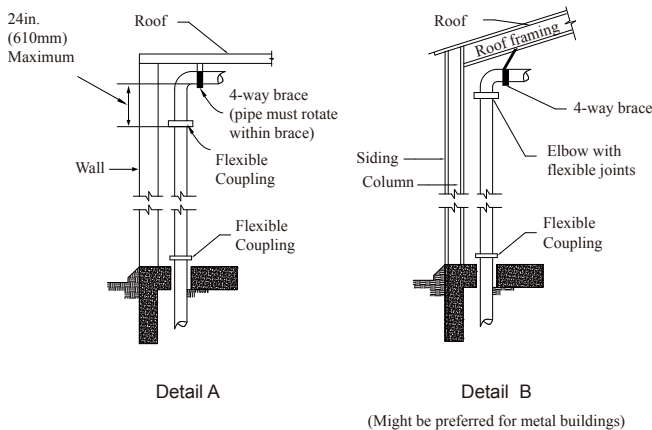

Note to Detail A: The four-way brace should be attached above the upper flexible coupling required for the riser and preferably to the roof structure if suitable. The brace should not be attached directly to a plywood or metal deck.

FIGURE A.9.3.2(a) Riser Details.

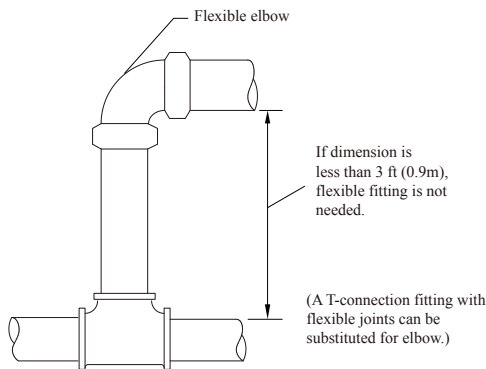

FIGURE A.9.3.2(b) Detail at Short Riser

2. Flexible couplings on horizontal portion of Tie-In

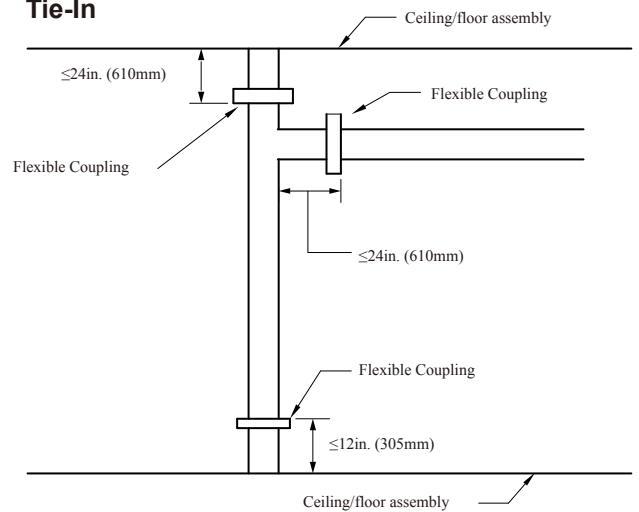

FIGURE A.9.3.2.3(2) (a) Flexible Coupling on Horizontal Portion of Tie-In.

3. Flexible couplings on Main Riser and Branch Line Riser

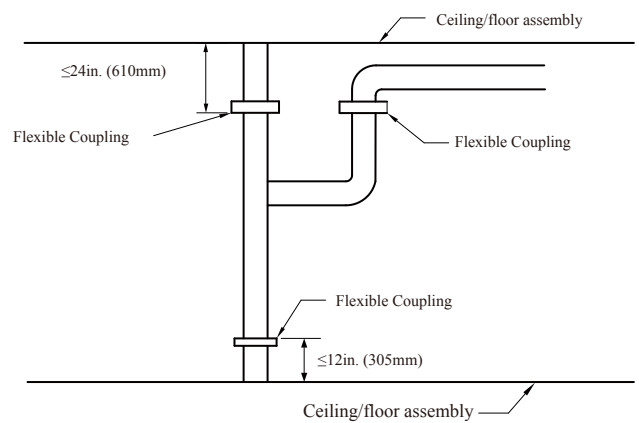

FIGURE A.9.3.2.3(2) (b) Flexible Coupling on Main Riser And Branch Line Riser

4. Flexible couplings for drops

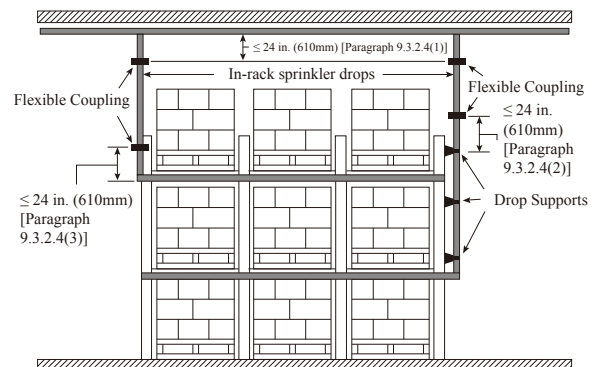

FIGURE A.9.3.2.4 Flexible Coupling for Drops

5. Seismic Separation Assembly

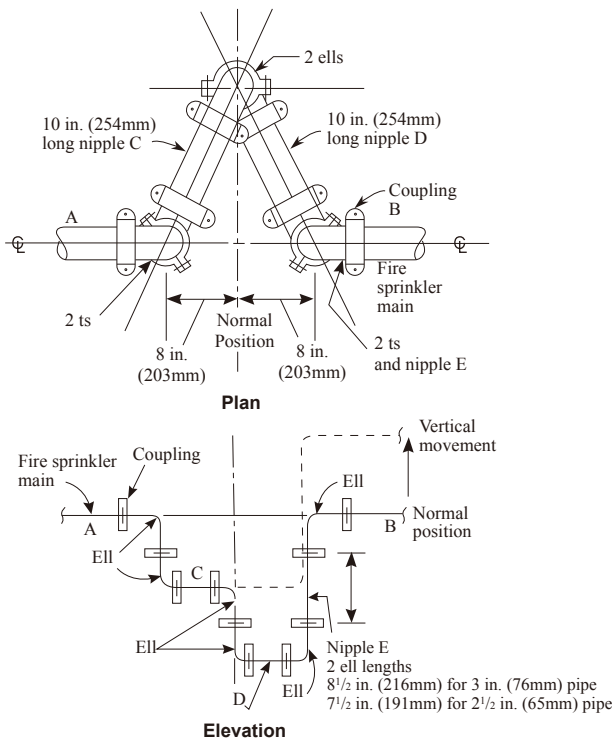

FIGURE A.9.3.3 (a) Seismic Separation Assembly. Shown are an 8 in. (203mm) Separation Crossed by Pipes up to 4 in. (102mm) in Nominal Diameter. For other separation distances and pipe sizes, lengths and distances should be modified proportionally.

6. Earthquake protection for sprinkler piping

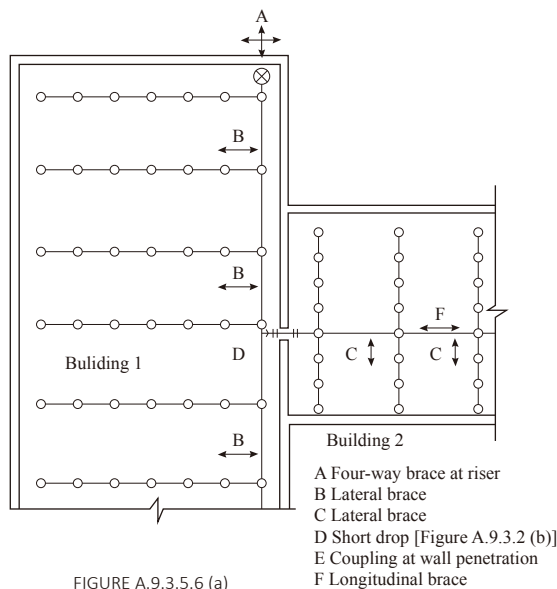
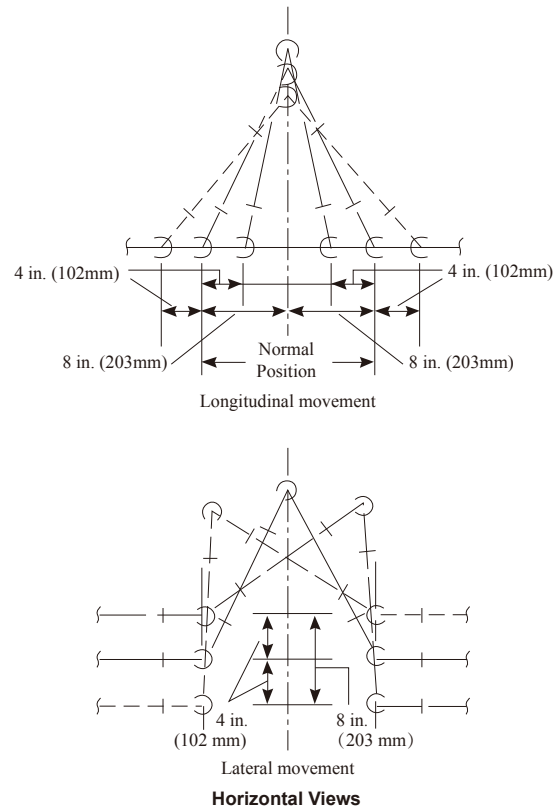

FIGURE A.9.3.5.6 (a)



7. Typical Location of Bracing on a Looped System

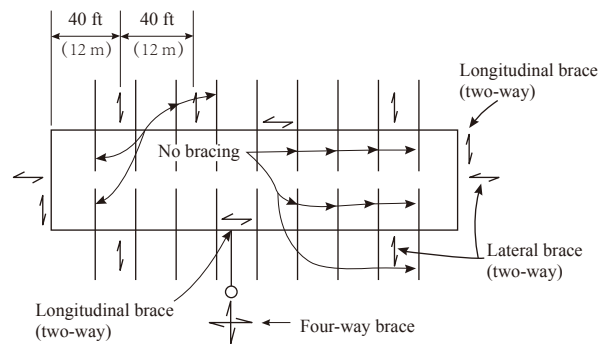

FIGURE A.9.3.5.6 (d)
Typical Location of Bracing on a Looped System.

Systems having more flexible couplings than required above shall be provided with additional sway bracing. A lateral brace shall be provided within 24" (600mm) of every other coupling unless pipes are supported by rods less than 6" (152mm) long from the veiling or by U-type hooks underside of the structural element. (NFPA 13 - 2007 9.3.2. & 9.3.5.)

ANCHORING, HANGING AND SUPPORTS

The grooved couplings are designed to hold axial thrusts 4-5 times their rated working pressure, though the strength against bending movement is less than that of steel pipe. The joint may be damaged when a bending movement greater than the allowed deflection occurs. System designers should provide anchors (main and intermediate) and pipe guides with proper spacing to protect the system from unexpected large bending movements.

These illustrations are examples only, and are not intended to be used for all installations as conditions and requirements vary from job to job. Reliance on general data or information contained herein shall be at the user's sole risk and without obligation to Lede.

Hangers shall be designed to support five times the weight of water-filled pipe plus 250 lb (115 kgs) at each point of pipe support (NFPA 13 9.1.1.1.). The following illustrations are examples of acceptable hanger types and size per NFPA 13.

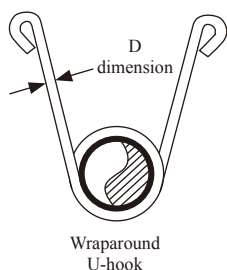

U-Hook sizes

Pipe size in	D dimension in/mm
~2	5/16 (7.9)
2-1/2 ~ 6	3/8 (9.5)
8	1/2 (12.7)

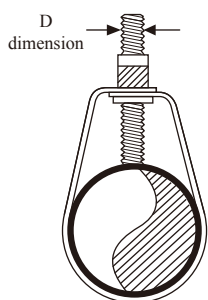

Rod sizes

Pipe size in	D dimension in/mm
~ 4	3/8 (9.5)
5 ~ 4	1/2 (12.7)
10 ~ 12	5/8 (15.9)

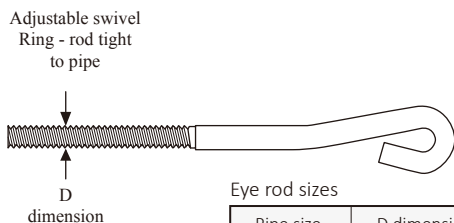

Eye rod sizes

Pipe size in	D dimension in/mm
~ 4	3/8 (9.5)
5 ~ 6	1/2 (12.7)
10 ~ 12	3/4 (15.1)

Hangers for straight runs

For straight runs, you can use both flexible and rigid couplings. When rigid couplings are used, the same hanger spacing as other piping methods can be applied. You can refer to the hanger spacing standards of ANSI B31.1 Power Piping Code, B31.9 Building Services Piping Code, NFPA 13 Sprinkler Systems, or Mechanical Equipment Construction Guide (Japan). See the table below.

Nominal Pipe Size in/mm	Suggested Max. Span between Supports (steel pipe)					
	Water Service (meters)				Gas or Air Service (meters)	
	1)	2)	3)	4)	1)	2)
1/25	2.1	2.7	3.7	2.0	2.7	2.7
1.25/32	2.1	3.4	3.7	2.0	2.7	3.4
1.5/40	2.1	3.7	4.6	2.0	2.7	4.0
2/50	3.1	4.0	4.6	2.0	4.0	4.6
3/80	3.7	4.6	4.6	2.0	4.6	5.2
4/100	4.3	5.2	4.6	2.0	5.2	6.4
6/150	5.2	6.1	4.6	3.0	6.4	7.6
8/200	5.8	6.4	4.6	3.0	7.3	8.5
10/250	5.8	6.4		3.0	7.3	9.5
12/300	7.0	6.4		3.0	9.1	10.1
14/350	7.0	6.4			9.1	10.1
16/400	8.2	6.4			10.7	10.1
18/450	8.2	6.4			10.7	10.1
20/500	9.1	6.4			11.9	10.1
24/600	9.8	6.4			12.8	10.1

- 1) ANSI B31.1 Power Piping Code
- 2) ANSI B31.9 Building Services Piping Code
- 3) NFPA 13 Sprinkler systems
- 4) Ministry of Land & Transportation of Japan: Mechanical Equipment Construction Guide

Hanger locations on straight runs where flexible couplings are used

When flexible couplings are used on straight runs, location of hangers shall be designed as close to each coupling as possible, or within a distance of less than 1/6 the span.

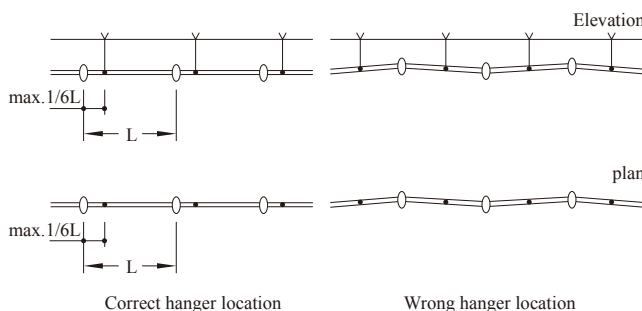

Hanger locations on curved pipe runs and branch lines

Additional hangers or supports shall be provided where runs are curved, connected to a branch line or on short risers or drops.

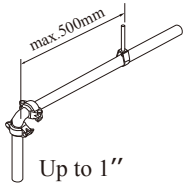

Up to 1"

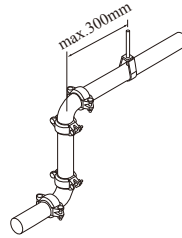

Short riser (or short drop)

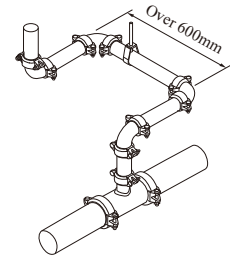

Branch line

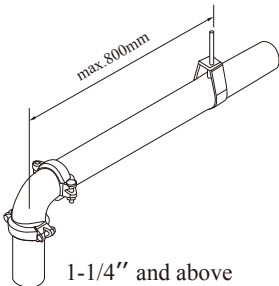

1-1/4" and above
Curved pipe runs

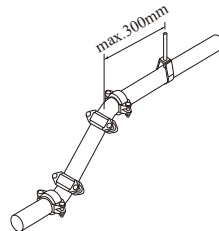

Typical designs of hangers and sway braces for pipe runs

Pipe runs shall be adequately suspended by rod hangers or steel angles that are directly attached to the building

structure to restrict the movement of the piping. Hangers and their components shall be ferrous. The maximum distance between hangers shall not exceed that specified in the table of previous page.

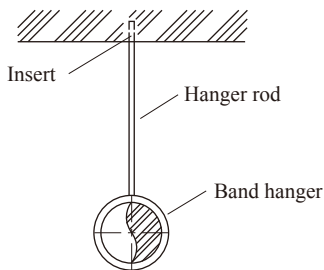

A rod hanger for a single pipe run

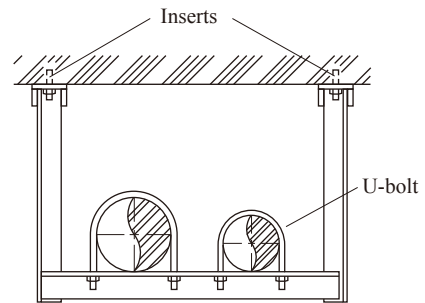

A trapeze hanger suspended from ceiling

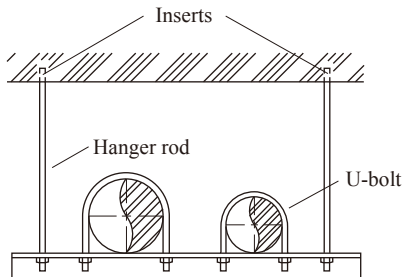

A trapeze hanger for multiple pipe runs

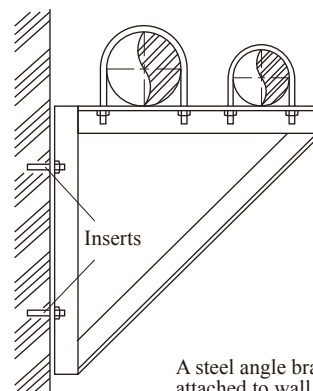

A steel angle bracket attached to wall

Supports for risers

In multi-story buildings, risers shall be fixed (or anchored) at the lowest level and at the top of the riser and shall be supported by riser clamps or U-bolts at each floor level to prevent the risers from swaying. If risers are braced by the penetration floors, the number of riser clamps or U-bolts may be reduced to one at each three stories. For risers, either flexible or rigid couplings can be used as long as proper anchoring and support is provided.

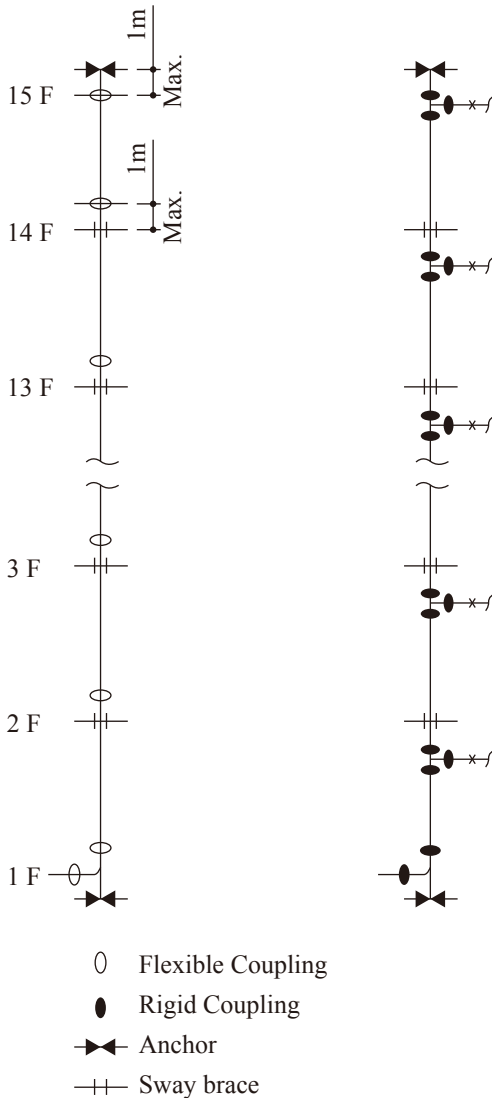

Anchors for risers (➔➔)

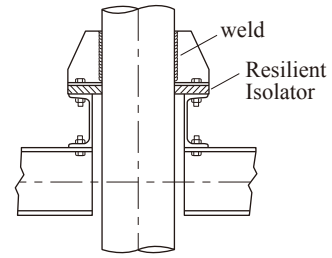

Sway braces for risers (⊕)

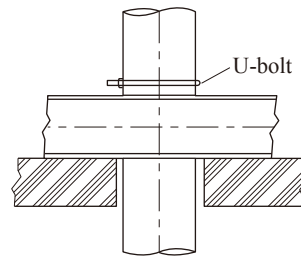

Anchor (➔➔)

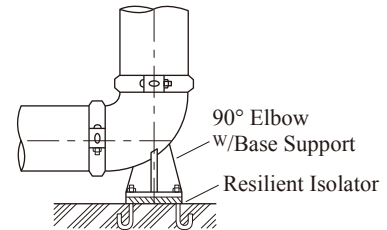

Sway brace (⊕)

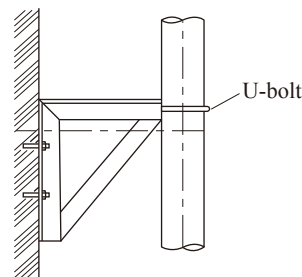

Sway brace (⊕)

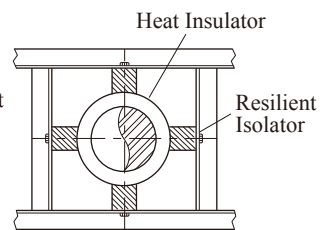

- Anchors should be sufficient to hold the weight of water-filled pipe and pressure thrusts.
- Pipe guides (sway braces) should be such as to brace lateral movement of the system.

GASKET SELECTION GUIDE

We utilize the finest gasket materials available in our products. Over the past 50 years great advances have been made in synthetic elastomer technologies, allowing us to offer a full range of synthetic rubber gasket materials for a wide variety of piping applications. Lede gaskets are engineered and designed to meet and exceed standards such as ASTM D2000, AWWA C606, NSF61 and IAPMO. Our own stringent internal laboratory testing confirms this. Our continual research, development and testing are designed to advance the elastomer field and to develop new and better solutions for our ever-changing industry.

Chemical resistance is primarily determined by the grade

and or the compound of the gasket. The color coding identifies the gasket grade and or compound. Always verify that the gasket selected is correct for the intended service.

Service temperature is controlled by factors including the gasket compound, fluid medium (air, water, oils, etc.), and continuity (continuous or intermittent) of service. Under no circumstances should gaskets be exposed to temperatures below their individual ratings. For additional information or specific applications contact Lede for recommendations.

Standard Gaskets

Compound	Grade	Color Code	Recommended Services	Maximum Temp. Range
EPDM	E	Green Stripe	Good for cold & hot water up to +230°F (+110°C). Also good for services for water with acid, water with chlorine, deionized water, seawater and waste water, dilute acids, oil-free air and many chemicals. Not recommended for petroleum oils, solvents and aromatic hydrocarbons.	-29°F (-34°C) to +230°F (+110°C)
Nitrile	T	Orange Stripe	Good for petroleum oils, mineral oils, vegetable oils, aromatic hydrocarbons, many acids and water ≤ +150°F (+65°C).	-20°F (-29°C) to +180°F (+82°C)
White Nitrile	A	White Gasket	Good for oily and greasy food products and processing, as well as pharmaceutical and cosmetics manufacturing. Compounded from FDA approved ingredients (CFR Title 21 Part 177.2600).	-20°F (-7°C) to +180°F (+82°C)
Silicone	L	Red Stripe	Good for dry, hot air without hydrocarbons and some high temperature chemical services. May also be used for fire protection dry systems.	-29°F (-34°C) to +350°F (+177°C)
Fluoro-elastomer (Viton)	O	Blue Stripe	Good for many oxidizing acids, petroleum oils, halogenated hydrocarbons, lubricants, hydraulic fluids, organic liquids and air with hydrocarbons to +300°F (+149°C).	-20°F (-7°C) to +300°F (+149°C)

GASKET STYLES

Due to the number of Lede products offered and the variety of service applications, a wide variety of gaskets are available. Even though the products and gaskets may look

different the sealing principles remain the same. The following are some of the most common gasket styles.

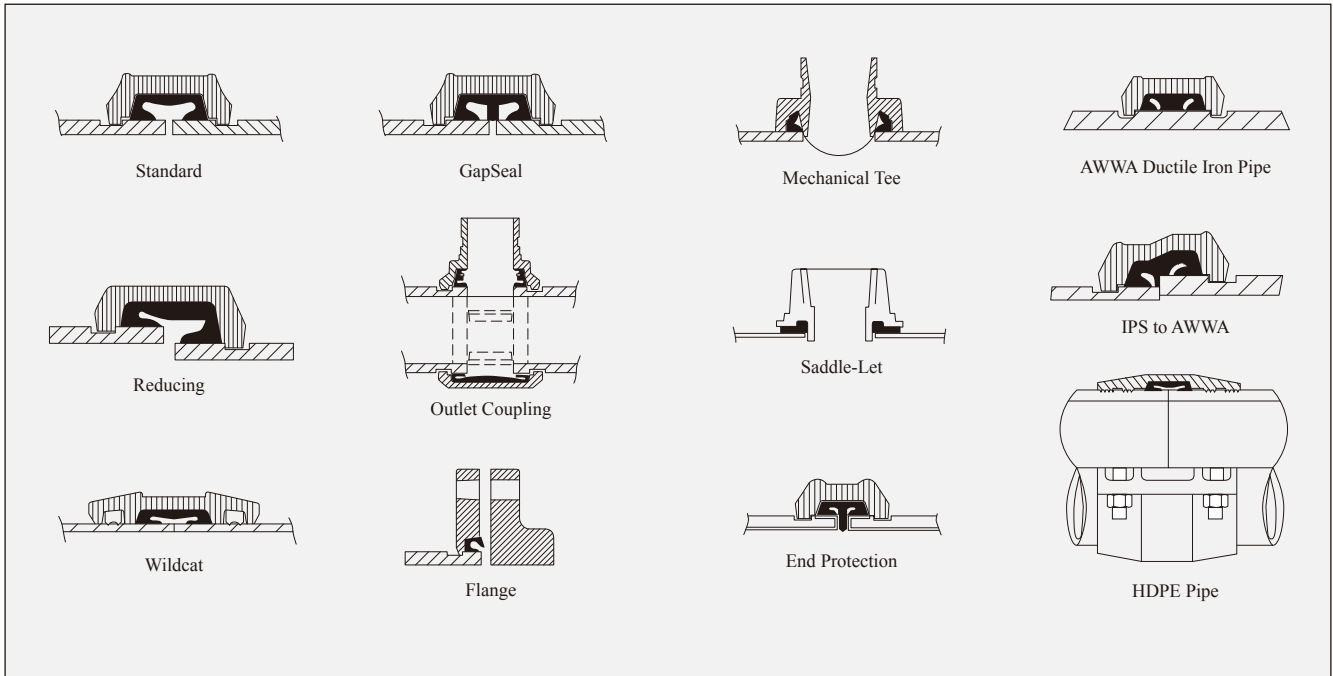

VACUUM SERVICE

The standard gaskets are designed to seal well under vacuum conditions up to 10 inHg (254 mmHg) which may occur when a system is drained. For continuous services greater than 10 inHg (254 mmHg), the use of **GapSeal** gaskets or EP (end protection) gaskets in combination with rigid style couplings is recommended. Contact Lede for specific recommendations.

Do not use the normal lubricant for dry pipe and freezer systems. Always use a petroleum free silicone based lubricant.

Rigid couplings are preferred for dry pipe, freezer and vacuum applications. Reducing couplings are not recommended for these applications.

DRY PIPE AND FREEZER SERVICES

We recommend the use of **GapSeal** Grade E gaskets for dry pipe fire protection systems and freezer applications. The **GapSeal** gasket close off the gap between the pipes or gasket cavity. This will prevent any remaining liquid from entering the cavities and freezing when the temperature drops.



GapSeal Gasket

PIPE END PREPARATION

How to process roll-grooves

The grooved piping systems require the processing of a roll or cut groove to the pipe ends being connected. The engagement of the housing keys in the grooves is integral in providing a secure and leak-tight joint. It is essential that the grooves are properly processed for optimum joint performance.

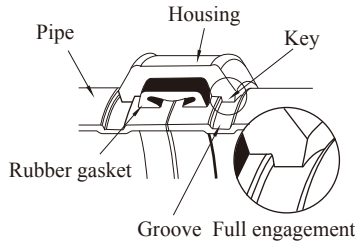

Nominal pipe size

The couplings and fittings are identified by the nominal IPS pipe size in inches or nominal diameter of pipe (DN) in

IPS Sizes - Inches		Metric Sizes - millimeters	
Nominal size	Actual size	Nominal size	Actual size
1/2	0.840	15	21.3
3/4	1.050	20	26.7
1	1.315	25	33.4
1-1/4	1.660	32	42.2
1-1/2	1.900	40	48.3
2	2.375	50	60.3
2-1/2	2.875	65	73.0
3 O.D.	3.000	65	76.1
3	3.500	80	88.9
3-1/2	4.000	90	101.6
4-1/4 O.D.	4.250	100	108.0
4	4.500	100	114.3
5	5.563	125	141.3
5-1/4 O.D.	5.250	125	133.0
5-1/2 O.D.	5.500	125	139.7
6-1/4 O.D.	6.250	150	159.0
6-1/2 O.D.	6.500	150	165.1
6	6.625	150	168.3
8 JIS	8.516	200	216.3*
8	8.625	200	219.1
10 JIS	10.528	250	267.4*
10	10.750	250	273.0
12 JIS	12.539	300	318.5*
12	12.750	300	323.9
14	14.000	350	355.6
16	16.000	400	406.4
18	18.000	450	457.2
20	20.000	500	508.0
22	22.000	550	558.8
24	24.000	600	609.6
28	28.000	700	711.2
30	30.000	750	762.0
32	32.000	800	812.8
36	36.000	900	914.4
40	40.000	1000	1016.0
42	42.000	1050	1066.8

* JIS/KS

millimeters. Always check the actual O.D. of the pipe and fittings to be connected, as in some markets it is customary to refer to different O.D. pipes with the same nominal size.

Roll groove standard

Roll grooves must meet the specifications and requirements of ANSI/AWWA C-606-04 Table 5. For other pipe sizes not specified in this standard, refer to the applicable groove specifications shown in this catalog or Lede installation manual.

Square cut

Pipe ends must be square cut. Always use a pipe band-saw or automatic round-saw for cutting pipe. The maximum allowable tolerances from square ends are .03"/0.8mm for sizes up to 3-1/2"/90mm; .045"/1.2mm for 4" thru 6"/100mm thru 150mm and .060"/1.6mm for size 8"/200mm and above.

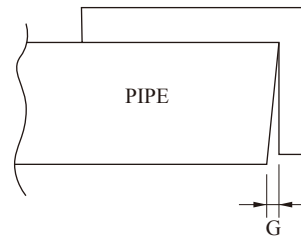

Pipe Sizes	G (max)
~3 1/2"	0.8 (0.030")
4 ~ 6"	1.2 (0.045")
8" ~	1.6 (0.060")

Applicable pipe wall thickness

Roll grooves are generally applicable to .375"/9.5mm thick or thinner wall carbon steel pipe, stainless steel pipe, copper tube, aluminum pipe and PVC pipe depending on the type of roll-grooving machine and roll set being used. Different wall thicknesses and sizes require the use of different roll sets as with Sch. 10 and Sch. 40 pipe as shown.

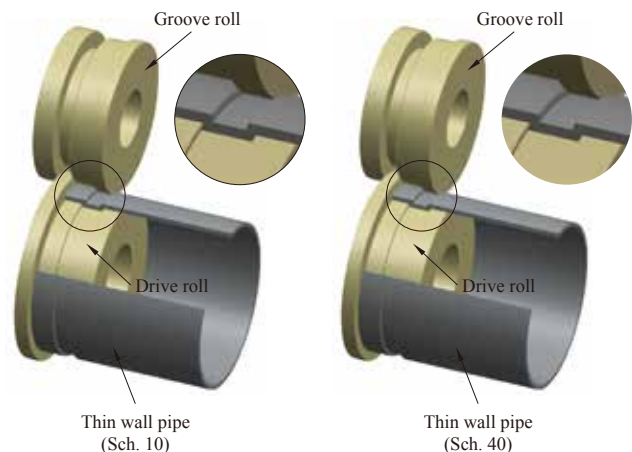

Different roll set (Groove & Drive roll)
W2 should be wider than W1

Plain end pipe and beveled end pipe

While plain-end pipe is preferred, the use of beveled end pipe is acceptable providing that the wall thickness is $.375''/9.5\text{mm}$ or thinner and the bevel is $37\frac{1}{2} \pm 2\text{-}1\frac{1}{2}^\circ$ or 30° as specified in ANSI B16.25 and ASTM A-53 respectively.

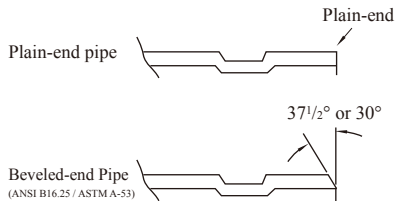

Galvanized pipe

Galvanized pipe is acceptable as long as the gasket seating surface is smooth and free from scale and imperfections that could affect gasket sealing. Whenever you remove welding beads or projections from the

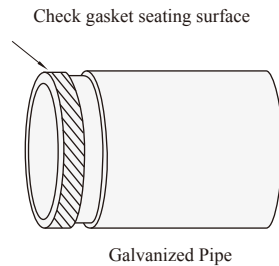

sealing surface of galvanized pipe, use caution so as to not over-grind the surface. After grinding, always apply a proper rust-prevention coating to this area.

Heavy wall pipe

When you attempt to roll-groove pipe thicker than $.375''/9.5\text{mm}$, the metal may deform and heap up on both sides of the groove rather than radially deforming and protruding on the inside of the pipe. The extra heaped metal on the sealing surface may preclude the coupling housing from making metal-to-metal contact, which could lead to joint failure. In such a case, you should grind off any such extra metal to achieve a flat and smooth sealing surface. A proper rust preventative coating must be applied on the ground surface. Lede strongly recommends the processing of cut-grooves on heavy or thick wall pipe.

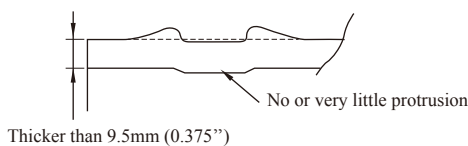

Weld Beads

ERW pipe is one of the most popular types of pipe used today. Depending on the individual pipe and manufacturer, welding beads may remain on the surface (inside and out) of the pipe. Always remove harmful weld beads near the pipe ends as they can cause rattling of the roll grooving machine resulting in inaccurate grooves.

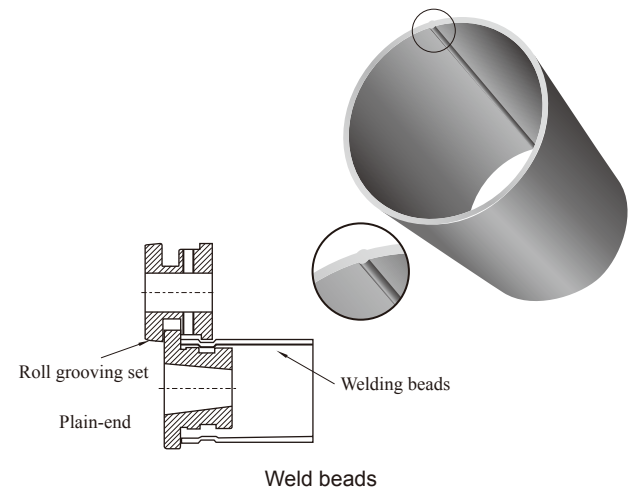

Spiral welded pipe

Spiral welded pipe may be used as long as the weld beads are removed from the gasket seating surface. It is also acceptable and recommended to weld a grooved end nipple to the pipe end as shown below. Whenever you remove weld beads or projections from the gasket seating surface, use caution so as to not over-grind the surface. After grinding, always apply a proper rust-prevention coating to this area.

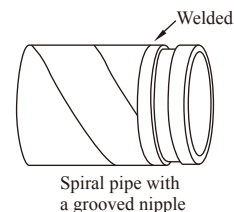
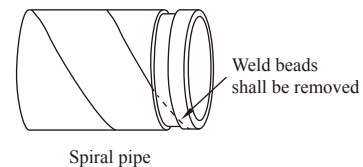

Stainless steel pipe

Stainless steel pipe in general is more difficult to groove than carbon steel pipe, as it is more difficult to achieve defined groove corners on stainless pipe. Grooves that are not defined and have too much of a radius could result in joint failure. Care must be taken to process grooves as defined as possible. For this reason, roll-groove machine manufactures offer a variety of roll sets depending on the pipe material and wall thickness being grooved. Always select the correct roll set for the pipe being grooved.

Corners are not sharp enough

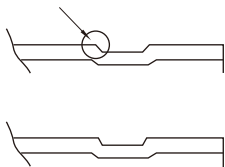

Caution: If the same roll-set that has been used for carbon steel pipe is used on stainless steel pipe, rust or scale may be transferred to the stainless steel pipe during processing of the groove. Thus we recommend the use of a separate roll set specifically for use with stainless steel pipe. Also use caution to keep roll grooved stainless steel pipe dry prior to installation.

PVC pipe

The same roll set used for carbon steel pipe can be used on applicable PVC pipe. Because PVC is much softer than carbon steel, care must be taken to groove the pipe slowly and with less pressure.



Copper tubing

As copper tubing is thinner than carbon steel pipe, always use a roll set specifically designed for use on copper tubing.

Gasket seating surface (A)

The exterior surface of the gasket seating area shall be free from any indentations, projections, roll marks or other harmful defects such as loose paint, scale, dirt, chips, grease and rust.

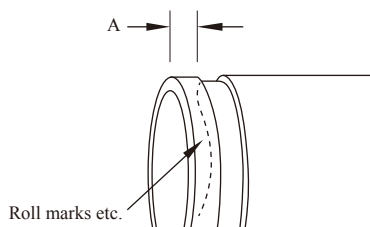

Roll groove profile

Roll grooves should be as defined as possible. To achieve optimum joint performance the “K” dimension should be as small as possible. When processing a roll groove the machine operator should manage the feed pressure of the upper roll set so as to achieve the best possible groove profile.

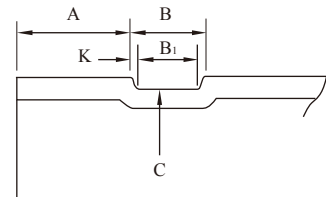

Groove diameter (C)

The groove diameters are average values. The groove must be of uniform depth around the entire pipe circumference. Use a Lede groove gage or groove measuring tape to check the groove diameter.

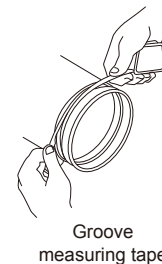

Groove measuring tape

Or you can use a coupling housing for a quick check after verification of the groove dimensions. When using a housing segment as a reference always make up a sample and verify the diameter is within the acceptable range. If the housing fits well you may choose to use this as a reference gauge.

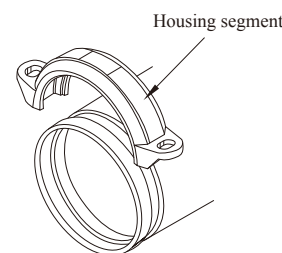

Quick check with a housing segment

HOLE-CUTTING

The hole-cut method of pipe preparation is required when using mechanical tees, mechanical crosses, and saddle-lets. The method of pipe preparation requires the

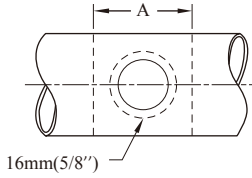

cutting or drilling of a specified hole size on the centerline of the pipe. Always use the correct hole saw size as shown in this catalog and never use a torch for cutting a hole. After the hole has been cut all rough edges must be removed and the area within 5/8" (16mm) of the hole should be inspected to ensure a clean smooth surface, free of any indentations or projections that could affect proper gasket sealing. The area within the "A" dimension should also be inspected and must be free of dirt, scale or any imperfection that could affect proper seating or assembly of the fitting.



Hole Size: The hole sizes are dictated by the branch size of the mechanical tee.

Table 1 Hole Sizes for Mechanical Tee

Model XGQT04/XGQT04G Mechanical Tee			
Mechanical Tees Branch Size	Hole Dimensions		Surface Preparation "A"
	Hole Saw Size	Max Dia. Allowed	
15, 20, 25 1/2, 3/4, 1	38 1-1/2	41 1-5/8	89 3-1/2
32 1-1/4	45 1-3/4	47 1-7/8	102 4
40 1-1/2	51 2	54 2-1/8	102 4
50 2	64 2-1/2	67 2-5/8	114 4-1/2
65 2-1/2	70 2-3/4	73 2-7/8	121 4-3/4
80 3	89 3-1/2	92 3-5/8	140 5-1/2
100 4	114 4-1/2	118 4-5/8	165 6-1/2

Table 2

Model 041 Saddle-Let			
U Bolt Mechanical Tee Branch Size	Hole Dimensions		Surface Preparation "A"
	Hole Saw Size	Max Dia. Allowed	
15, 20, 25 1/2, 3/4, 1	30 1-3/16	32 1-1/4	89 3-1/2

Table 3

Model L922 Mechanical Tee			
Small Mechanical Tees Branch Size	Hole Dimensions		Surface Preparation "A"
	Hole Saw Size	Max Dia. Allowed	
15, 20, 25 1/2, 3/4, 1	30 1-3/16	32 1-1/4	89 3-1/2

Standard Roll Groove for ANSI B36.10 and Other IPS Pipe

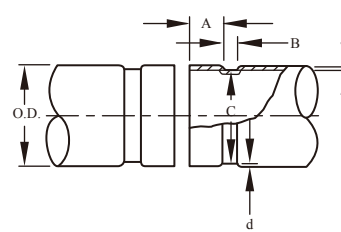

1 Nominal Size mm/in	2 Pipe O.D.		3 A ±0.76 ±0.030	4 B ±0.76 ±0.030	5 C +0.00 +0.000	6 Min. Wall t mm/in	7 Groove Depth d (ref.) mm/in	8 Max. Allowed Flare Dia. mm/in
	Basic mm/in	Tolerances						
20	26.7	+0.25 -0.25	15.88	7.14	23.83-0.38	1.65	1.42	29.2
0.75	1.050	+0.010 -0.010	0.625	0.281	0.938-0.015	0.065	0.056	1.15
25	33.4	+0.33 -0.33	15.88	7.14	30.23-0.38	1.65	1.60	36.3
1	1.315	+0.013 -0.013	0.625	0.281	1.190-0.015	0.065	0.063	1.43
32	42.2	+0.41 -0.41	15.88	7.14	38.99-0.38	1.65	1.60	45.0
1.25	1.660	+0.016 -0.016	0.625	0.281	1.535-0.015	0.065	0.063	1.77
40	48.3	+0.48 -0.48	15.88	7.14	45.09-0.38	1.65	1.60	51.1
1.5	1.900	+0.019 -0.019	0.625	0.281	1.775-0.015	0.065	0.063	2.01
50	60.3	+0.61 -0.61	15.88	8.74	57.15-0.38	1.65	1.60	63.0
2	2.375	+0.024 -0.024	0.625	0.344	2.250-0.015	0.065	0.063	2.48
65	73.0	+0.74 -0.74	15.88	8.74	69.09-0.46	2.11	1.98	75.7
2.5	2.875	+0.029 -0.029	0.625	0.344	2.720-0.018	0.083	0.078	2.98
80	88.9	+0.89 -0.79	15.88	8.74	84.94-0.46	2.11	1.98	91.4
3	3.500	+0.035 -0.031	0.625	0.344	3.344-0.018	0.083	0.078	3.60
90	101.6	+1.02 -0.79	15.88	8.74	97.38-0.51	2.11	2.11	104.1
3.5	4.000	+0.040 -0.031	0.625	0.344	38.34-0.020	0.083	0.083	4.10
100	114.3	+1.14 -0.79	15.88	8.74	110.08-0.51	2.11	2.11	116.8
4	4.500	+0.045 -0.031	0.625	0.344	4.334-0.020	0.083	0.083	4.60
125	141.3	+1.42 -0.79	15.88	8.74	137.03-0.56	2.77	2.11	143.8
5	5.563	+0.056 -0.031	0.625	0.344	5.395-0.022	0.109	0.083	5.66
150	168.3	+1.60 -0.79	15.88	8.74	163.96-0.56	2.77	2.16	170.9
6	6.625	+0.063 -0.031	0.625	0.344	6.455-0.022	0.109	0.085	6.73
200	219.1	+1.60 -0.79	19.05	11.91	214.40-0.64	2.77	2.34	223.5
8	8.625	+0.063 -0.031	0.750	0.469	8.441-0.025	0.109	0.092	8.80
250	273.0	+1.60 -0.79	19.05	11.91	268.27-0.69	3.40	2.39	277.4
10	10.750	+0.063 -0.031	0.750	0.469	10.562-0.027	0.134	0.094	10.92
300	323.9	+1.60 -0.79	19.05	11.91	318.29-0.76	3.96	2.77	328.2
12	12.750	+0.063 -0.031	0.750	0.469	12.531-0.030	0.156	0.109	12.92
350	355.6	+1.60 -0.79	23.83	11.91	350.04-0.76	3.96	2.77	358.1
14	14.000	+0.063 -0.031	0.938	0.469	13.781-0.030	0.156	0.109	14.10
400	406.4	+1.60 -0.79	23.83	11.91	400.84-0.76	4.19	2.77	408.9
16	16.000	+0.063 -0.031	0.938	0.469	15.781-0.030	0.165	0.109	16.10
450	457.2	+1.60 -0.79	25.40	11.91	451.64-0.76	4.19	2.77	461.3
18	18.000	+0.063 -0.031	1.000	0.469	17.781-0.030	0.165	0.109	18.16
500	508.0	+1.60 -0.79	25.40	11.91	502.44-0.76	4.78	2.77	512.1
20	20.000	+0.063 -0.031	1.000	0.469	19.781-0.030	0.188	0.109	20.16
550	558.8	+1.60 -0.79	25.40	12.70	550.06-0.76	4.78	4.37	563.9
22	22.000	+0.063 -0.031	1.000	0.500	21.656-0.030	0.188	0.172	22.20
600	609.6	+1.60 -0.79	25.40	12.70	600.86-0.76	4.78	4.37	614.7
24	24.000	+0.063 -0.031	1.000	0.500	23.656-0.030	0.188	0.172	24.20

Pipe OD (Column 2):

Maximum allowable tolerances from square cut ends is 0.03" for size up to 3 1/2"; 0.045" for 4" thru 6"; and 0.060" for size 8" and above.

Gasket Seating Surface (Column 3):

The gasket seating surface shall be free from deep scores, marks, or ridges that could prevent a positive seal.

Groove Width (Column 4):

Groove width is to be measured between vertical flanks of the groove side walls.

Groove Diameter (Column 5):

The "C" diameters are average values. The groove must be of uniform depth around the entire pipe circumference.

Minimum Wall Thickness (Column 6):

The "t" is the minimum allowable wall thickness that may be roll-grooved.

Groove Depth (Column 7):

The "d" is for reference use only. The groove dimension shall be determined by the groove diameter "C".

Flare Diameter (Column 8):

The pipe end that may flare when the groove is rolled shall be within this limit when measured at the extreme end of the pipe.

Standard Roll Groove for Large Diameter IPS Pipe

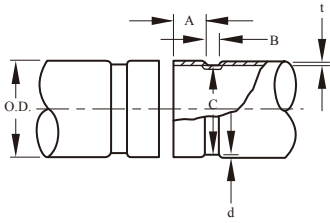

Pipe OD (Column 2):

Maximum allowable tolerances from square cut ends is 0.060”.

Gasket Seating Surface (Column 3):

The gasket seating surface shall be free from deep scores, marks, or ridges that could prevent a positive seal.

Groove Width (Column 4):

Groove width is to be measured between vertical flanks of the groove side walls.

Groove Diameter (Column 5):

The “C” diameters are average values. The groove must be of uniform depth around the entire pipe circumference.

Minimum Wall Thickness (Column 6):

The “t” is the minimum allowable wall thickness that may be roll-grooved.

Groove Depth (Column 7):

The “d” is for reference use only. The groove dimension shall be determined by the groove diameter “C”.

Flare Diameter (Column 8):

The pipe end that may flare when the groove is rolled shall be within this limit when measured at the extreme end of the pipe.

1 Nom. Size mm/in	2 Pipe O.D.			3 A +0.8, -1.6 +0.03, -0.06	4 B +0.8 +0.03	5 C +0, -1.6 +0, -0.063	6 Min. Allow Wall thick t mm/in	7 Groove Depth d (ref) mm/in	8 Max. Allowed Flare Dia. mm/in
	Basic mm/in	mm/in	Tolerances mm/in						
650	660.4	+2.36	-0.79	44.5	15.9	647.7	6.4	6.4	665.5
26 OD	26.0	+0.093	-0.031	1.75	0.625	25.5	0.25	0.25	26.2
700	711.2	+2.36	-0.79	44.5	15.9	698.5	6.4	6.4	716.3
28 OD	28.0	+0.093	-0.031	1.75	0.625	27.5	0.25	0.25	28.2
750	762.0	+2.36	-0.79	44.5	15.9	749.3	6.4	6.4	767.1
30 OD	30.0	+0.093	-0.031	1.75	0.625	29.5	0.25	0.25	30.2
800	812.8	+2.36	-0.79	44.5	15.9	800.1	6.4	6.4	817.9
32 OD	32.0	+0.093	-0.031	1.75	0.625	31.5	0.25	0.25	32.2
850	863.6	+2.36	-0.79	44.5	15.9	850.9	6.4	6.4	868.7
34 OD	34.0	+0.093	-0.031	1.75	0.625	33.5	0.25	0.25	34.2
900	914.4	+2.36	-0.79	44.5	15.9	901.7	6.4	6.4	919.5
36 OD	36.0	+0.093	-0.031	1.75	0.625	35.5	0.25	0.25	36.2
1000	1016.0	+2.36	-0.79	50.8	15.9	1003.3	6.4	6.4	1026.2
40 OD	40.0	+0.093	-0.031	2.00	0.625	39.5	0.25	0.25	40.4
1050	1066.8	+2.36	-0.79	50.8	15.9	1054.1	6.4	6.4	1071.9
42 OD	42.0	+0.093	-0.031	2.00	0.625	41.5	0.25	0.25	42.2

Standard Roll Groove for BS1387 (ISO 65) Carbon Steel Pipe

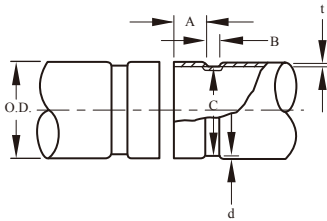

Pipe OD (Column 2):

Maximum allowable tolerances from square cut ends is 0.03” for size up to 3 1/2”; 0.045” for 4” thru 6”; and 0.060” for size 8” and above.

Gasket Seating Surface (Column 3):

The gasket seating surface shall be free from deep scores, marks, or ridges that could prevent a positive seal.

Groove Width (Column 4):

Groove width is to be measured between vertical flanks of the groove side walls.

Groove Diameter (Column 5):

The “C” diameters are average values. The groove must be of uniform depth around the entire pipe circumference.

Minimum Wall Thickness (Column 6):

The “t” is the minimum allowable wall thickness that may be roll-grooved.

Groove Depth (Column 7):

The “d” is for reference use only. The groove dimension shall be determined by the groove diameter “C”.

Flare Diameter (Column 8):

The pipe end that may flare when the groove is rolled shall be within this limit when measured at the extreme end of the pipe.

1 Nominal Size mm	2 Pipe O.D.			3 A +0.38, -0.76 mm	4 B +0.76/-0.38 mm	5 C +0.00 mm	6 Min. Wall t mm	7 Groove Depth d (ref) mm/in	8 Max. Allowed Flare Dia. mm
	Basic mm	Max mm	Min mm						
20	26.9	27.3	26.5	15.88	7.14	23.83-0.38	1.65	1.42	29.2
25	33.7	34.2	33.3	15.88	7.14	30.23-0.38	1.65	1.60	36.3
32	42.4	42.9	42.0	15.88	7.14	38.99-0.38	1.65	1.60	45.0
40	48.3	48.8	47.9	15.88	7.14	45.09-0.38	1.65	1.60	51.1
50	60.3	60.8	59.7	15.88	8.74	57.15-0.38	1.65	1.60	63.0
65	76.1	76.6	75.3	15.88	8.74	72.26-0.46	2.11	1.98	78.7
80	88.9	89.5	88.0	15.88	8.74	84.94-0.46	2.11	1.98	91.4
100	114.3	115.0	113.1	15.88	8.74	110.08-0.51	2.11	2.11	116.8
125	139.7	140.8	138.5	15.88	8.74	135.48-0.56	2.77	2.16	142.2
150	165.1	166.5	163.9	15.88	8.74	160.78-0.56	2.77	2.16	167.6

Standard Roll Groove for DIN 2440 & DIN 2448 (ISO 4200) Carbon Steel Pipe

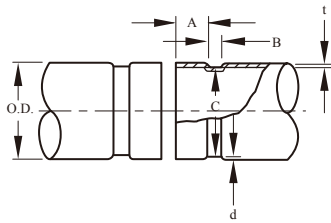

Pipe or Tube mm	Pipe O.D.		Gasket Seat A ±0.76 mm	Groove Width B ±0.76 mm	Groove Diameter		Groove Depth d (ref) mm	Min. allow. Wall Thickness t mm	Max. Flare f mm
	Basic mm	Tolerances			Basic C mm	Tolerance +0.00 mm			
25	33.7	+0.41 -0.68	15.88	7.14	30.23	-0.38	1.70	1.8	34.5
32	42.4	+0.50 -0.60	15.88	7.14	38.99	-0.38	1.70	1.8	43.3
40	48.3	+0.44 -0.52	15.88	7.14	45.09	-0.38	1.60	1.8	49.4
50	60.3	+0.61 -0.61	15.88	8.74	57.15	-0.38	1.60	1.8	62.2
65	76.1	+0.76 -0.76	15.88	8.74	72.26	-0.46	1.93	2.3	77.7
80	88.9	+0.89 -0.79	15.88	8.74	84.94	-0.46	1.98	2.3	90.6
100	108.0	+1.07 -0.79	15.88	8.74	103.73	-0.51	2.11	2.3	109.7
100	114.3	+1.14 -0.79	15.88	8.74	110.08	-0.51	2.11	2.3	116.2
125	133.0	+1.32 -0.79	15.88	8.74	129.13	-0.51	1.93	2.9	134.9
125	139.7	+1.40 -0.79	15.88	8.74	135.48	-0.51	2.11	2.9	141.7
150	159.0	+1.60 -0.79	15.88	8.74	154.50	-0.56	2.20	2.9	161.0
150	168.3	+1.60 -0.79	15.88	8.74	163.96	-0.56	2.16	2.9	170.7
200	219.1	+1.60 -0.79	19.05	11.91	214.40	-0.64	2.34	2.9	221.5
250	273.0	+1.60 -0.79	19.05	11.91	268.28	-0.69	2.39	3.6	275.4
300	323.9	+1.60 -0.79	19.05	11.91	318.29	-0.76	2.77	4.0	326.2

Pipe OD (Column 2):

Maximum allowable tolerances from square cut ends is 0.03" for size up to 3 1/2"; 0.045" for 4" thru 6"; and 0.060" for size 8" and above.

Gasket Seating Surface (Column 3):

The gasket seating surface shall be free from deep scores, marks, or ridges that could prevent a positive seal.

Groove Width (Column 4):

Groove width is to be measured between vertical flanks of the groove side walls.

Groove Diameter (Column 5):

The "C" diameters are average values. The groove must be of uniform depth around the entire pipe circumference.

Minimum Wall Thickness (Column 6):

The "t" is the minimum allowable wall thickness that may be roll-grooved.

Groove Depth (Column 7):

The "d" is for reference use only. The groove dimension shall be determined by the groove diameter "C".

Flare Diameter (Column 8):

The pipe end that may flare when the groove is rolled shall be within this limit when measured at the extreme end of the pipe.

Standard Roll Groove for JIS G3452 Carbon Steel Pipe

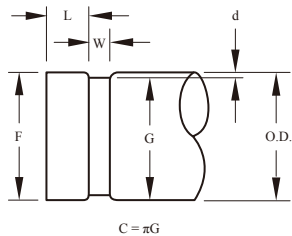

Nominal Size	Pipe O.D.		Gasket Seat L mm	Groove Width W mm	Groove Dia G mm		Groove Circumference C mm	Groove Depth d (ref) mm	Max. Flare f mm			
	A mm	B mm			G mm	G mm						
25	1	34.0	16.0	+0.4 -0.9	7.1	±0.8	30.4	0 -1.0	95.5	0 -3.1	1.80	35.5
32	1.25	42.7	16.0	+0.4 -0.9	7.1	±0.8	39.1	0 -1.0	122.8	0 -3.1	1.80	44.2
40	1.5	48.6	16.0	+0.4 -0.9	7.1	±0.8	45.0	0 -1.0	141.4	0 -3.1	1.80	50.1
50	2	60.5	16.0	+0.4 -0.9	8.7	±0.8	56.9	0 -1.0	178.8	0 -3.1	1.80	62.0
65	2.5	76.3	16.0	+0.4 -0.9	8.7	±0.8	72.2	0 -1.0	226.8	0 -3.1	2.05	77.8
80	3	89.1	16.0	+0.4 -0.9	8.7	±0.8	84.9	0 -1.0	266.7	0 -3.1	2.10	90.6
100	4	114.3	16.0	+0.4 -0.9	8.7	±0.8	110.1	0 -1.0	345.9	0 -3.1	2.10	116.8
125	5	139.8	16.0	+0.4 -0.9	8.7	±0.8	135.5	0 -1.0	425.7	0 -3.1	2.15	142.3
150	6	165.2	16.0	+0.4 -0.9	8.7	±0.8	160.8	0 -1.0	505.2	0 -3.1	2.20	167.7
200	8	216.3	19.0	±0.8	11.9	±0.8	(211.6)		664.8	0 -3.1	2.35	219.8
250	10	267.4	19.0	±0.8	11.9	±0.8	(262.6)		825.0	0 -3.1	2.40	270.9
300	12	318.5	19.0	±0.8	11.9	±0.8	(312.9)		983.0	0 -3.1	2.80	322.0

Groove Diameter:

Groove diameters 'G' are only applicable to pipe size 150A or smaller. Grooves for 200A thru 300A are to be determined by the groove circumference.

Groove Depth:

The "d" is for reference use only.

Flare Diameter:

The maximum flare diameters (f) are target values.

CUT GROOVE SPECIFICATIONS

Standard Cut Groove for Specifications for IPS / BS / ISO / JIS Pipe

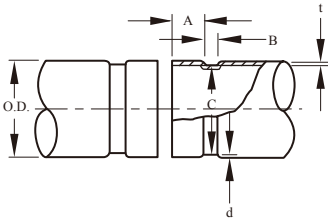

Gasket Seating Surface (Column 3):

The gasket seating surface shall be free from deep scores, marks, or ridges that could prevent a positive seal.

Groove Width (Column 4):

Groove width is to be measured between vertical flanks of the groove side walls.

Groove Diameter (Column 5):

The 'C' diameters are average values. The groove must be of uniform depth around the entire pipe circumference.

Minimum Wall Thickness (Column 6):

The 't' is the minimum allowable wall thickness that may be roll-grooved.

Groove Depth (Column 7):

The 'd' is for reference use only. The groove dimension shall be determined by the groove diameter 'C'.

1 Nominal Size mm/in	2 Pipe O.D.		3 A ±0.79 ±0.031	4 B ±0.79 ±0.031	5 C +0.00 +0.000	6 Min. Wall t mm/in	7 Groove Depth d (ref.) mm/in
	Basic mm/in	Tolerances					
20	26.7	+0.25 -0.25	15.88	7.95	23.83-0.38	2.87	1.42
0.75	1.050	+0.010 -0.010	0.625	0.313	0.938-0.015	0.113	0.056
25	33.4	+0.33 -0.33	15.88	7.95	30.23-0.38	3.38	1.60
1	1.315	+0.013 -0.013	0.625	0.313	1.190-0.15	0.133	0.063
32	42.2	+0.41 -0.41	15.88	7.95	38.99-0.38	3.56	1.60
1.25	1.660	+0.016 -0.016	0.625	0.313	1.535-0.015	0.140	0.063
40	48.3	+0.48 -0.48	15.88	7.95	45.09-0.38	3.68	1.60
1.5	1.900	+0.019 -0.019	0.625	0.313	1.775-0.015	0.145	0.063
50	60.3	+0.61 -0.61	15.88	7.95	57.15-0.38	3.91	1.60
2	2.375	+0.024 -0.024	0.625	0.313	2.250-0.015	0.154	0.063
65	73.0	+0.74 -0.74	15.88	7.95	69.09-0.46	4.78	1.98
2.5	2.875	+0.029 -0.029	0.625	0.313	2.720-0.018	0.188	0.078
65	76.1	+0.76 -0.76	15.88	7.95	72.26-0.46	4.78	1.93
2.5	3.000	+0.030 -0.030	0.625	0.313	2.845-0.018	0.188	0.076
80	88.9	+0.89 -0.79	15.88	7.95	84.94-0.46	4.78	1.98
3	3.500	+0.035 -0.031	0.625	0.313	3.344-0.018	0.188	0.078
90	101.6	+1.02 -0.79	15.88	7.95	97.38-0.51	4.78	1.98
3.5	4.000	+0.040 -0.031	0.625	0.313	3.834-0.020	0.188	0.078
100	108.0	+1.04 -0.79	15.88	9.53	103.73-0.51	5.16	2.11
4	4.250	+0.043 -0.031	0.625	0.375	4.084-0.020	0.203	0.083
100	114.3	+1.14 -0.79	15.88	9.53	110.08-0.51	5.16	2.11
4	4.500	+0.045 -0.031	0.625	0.375	4.334-0.020	0.203	0.083
125	133.0	+1.70 -0.79	15.88	9.53	129.13-0.51	5.16	1.93
5	5.250	+0.053 -0.031	0.625	0.375	5.084-0.020	0.203	0.076
125	139.7	+1.42 -0.79	15.88	9.53	135.48-0.51	5.16	2.11
5	5.500	+0.055 -0.031	0.625	0.375	5.334-0.020	0.203	0.083
125	141.3	+1.42 -0.79	15.88	9.53	137.03-0.56	5.16	2.11
5	5.563	+0.056 -0.031	0.625	0.375	5.395-0.022	0.203	0.083
150	159.0	+1.60 -0.79	15.88	9.53	154.43-0.76	5.56	2.20
6	6.250	+0.063 -0.031	0.625	0.375	6.080-0.030	0.219	0.087
150	165.1	+1.60 -0.79	15.88	9.53	160.80-0.56	5.56	2.16
6	6.500	+0.063 -0.031	0.625	0.375	6.330-0.022	0.219	0.085
150	168.3	+1.60 -0.79	15.88	9.53	163.966-0.56	5.56	2.16
6	6.625	0.063 -0.031	0.625	0.375	6.455-0.022	0.219	0.085
200A	216.3	+1.60 -0.79	19.05	11.13	211.60-0.64	6.05	2.34
8	8.516	+0.063 -0.031	0.750	0.438	8.331-0.025	0.238	0.092
200	219.1	+1.60 -0.79	19.05	11.13	214.40-0.64	6.05	2.34
8	8.625	+0.063 -0.031	0.750	0.438	8.441-0.025	0.238	0.092
250A	267.4	+1.60 -0.79	19.05	12.70	262.60-0.69	6.35	2.39
10	10.528	+0.063 -0.031	0.750	0.500	10.339-0.027	0.250	0.094
250	273.0	+1.60 -0.79	19.05	12.70	268.27-0.69	6.35	2.39
10	10.750	0.063 -0.031	0.750	0.500	10.526-0.027	0.250	0.094
300A	318.5	+1.60 -0.79	19.05	12.70	312.90-0.76	7.09	2.77
12	12.539	+0.063 -0.031	0.750	0.500	12.319-0.030	0.279	0.109
300	323.9	+1.60 -0.79	19.05	12.70	318.29-0.76	7.09	2.77
12	12.750	+0.063 -0.031	0.750	0.500	12.530-0.030	0.279	0.109
350	355.6	+1.60 -0.79	23.83	12.70	350.04-0.76	7.14	2.77
14	14.000	+0.063 -0.031	0.938	0.500	13.781-0.030	0.281	0.109
400	406.4	+1.60 -0.79	23.83	12.70	400.84-0.76	7.92	2.77
16	16.000	0.063 -0.031	0.938	0.500	15.781-0.030	0.312	0.109
450	457.2	+1.60 -0.79	25.40	12.70	451.64-0.76	7.92	2.77
18	18.000	+0.063 -0.031	1.000	0.500	17.781-0.030	0.312	0.109
500	508.0	+1.60 -0.79	25.40	12.70	502.44-0.76	7.92	2.77
20	20.000	+0.063 -0.031	1.000	0.500	19.781-0.030	0.312	0.109
550	558.8	+1.60 -0.79	25.40	14.30	550.06-0.76	9.53	4.37
22	22.000	+0.063 -0.031	1.000	0.563	21.656-0.030	0.375	0.172
600	609.6	+1.60 -0.79	25.40	14.30	600.86-0.76	9.53	4.37
24	24.000	+0.063 -0.031	1.000	0.563	23.656-0.030	0.375	0.172

BOLT TORQUES

The couplings and mechanical tees are supplied complete with factory bolts and nuts. The bolt and nut torque is primarily a function of the bolt and nut size. The following table shows guidelines for nut and bolt torque and can be used when setting the torque on power drivers.

Design Bolt Torques

Bolt Size in/mm	N-m Lbs - ft	Bolt Size in/mm	N-m Lbs - ft
5/16	25 - 30	3/4	270 - 300
M8	18 - 22	M20	200 - 220
3/8	60 - 70	7/8	270 - 300
M10	45 - 50	M22	200 - 220
1/2	90 - 100	1	320 - 340
M12	65 - 75	M24	235 - 250
5/8	200 - 230		
M16	145 - 170		

Do not exceed the design torque guidelines by more than 25%, as excessive torque could lead to joint failure. Always tighten nuts evenly and equally by alternating sides to prevent the gasket from being pinched and always check to make sure the coupling keys are fully engaged in the grooves.

FLEXIBLE COUPLINGS

The bolt pads on flexible couplings have been designed to meet metal to metal when properly installed. Bolt pad gaps,

regardless of their size, are not acceptable on flexible couplings. The listed values in the table 1 are guideline torque values listed by the coupling size. Please note these are only guidelines and that the actual torque value may be less than those listed to achieve a proper assembly. Actual torques for assembly of flexible couplings are normally as little as 15-20 N-m (11-15 Lbs-ft) for the bolt size of M10 (3/8") and 30-40 N-m (22 to 30 Lbs-ft) for the M12 (1/2") bolt size. Do not attempt to add further torque after the bolt pads make metal to metal contact.

If the bolt pads do not make full metal to metal contact, increase the torque to the listed guideline in table 1. Do not exceed the listed torque by more than 25%, as excessive torque could lead to joint failure. If bolt pad gaps still exist after bolts and nuts have been tightened to the guideline torque, then this would indicate a problem in the assembly, pipe and or groove dimensions.

ANGLE-PAD RIGID COUPLINGS

The bolt pads on angle-pad rigid couplings and butt-joint rigid couplings have been designed to meet metal to metal when properly installed. In addition as the bolts are tightened the bolt pads will slide against one another creating a slight off-set. This offset should be equal on each side and is your visual indication that the coupling has been installed properly for a rigid connection. Bolt pad gaps, regardless of their size, are not acceptable on angle-pad coupling. The listed values in the table 2 are guideline torque values listed by the coupling size. Please note these are only guidelines and that the actual torque value may be less than those listed to achieve a proper assembly.

Table 1
Flexible Coupling Torque Guidelines

Bolt Size in	XGQT2 N-m/Lbs-ft	1212 N-m/Lbs-ft
1	60-70	---
	45-50	---
1-1/4	60-70	60-70
	45-50	45-50
1-1/2	60-70	60-70
	45-50	45-50
2	60-70	60-70
	45-50	45-50
2-1/2	60-70	90-100
	45-50	65-75
3	60-70	90-100
	45-50	65-75
4	90-100	90-100
	65-75	65-75
5	90-100	200-230
	65-75	145-170
6	90-100	200-230
	65-75	145-170
8	200-230(JIS216 270-300)	270-300
	145-170(JIS216 200-220)	200-220
10	270-300	270-300
	200-220	200-220
12	270-300	270-300
	200-220	200-220
14	270-300	---
	200-220	---
16	270-300	---
	200-220	---
18	270-300	---
	200-220	---
20	270-300	---
	200-220	---
22	270-300	---
	200-220	---
24	320-340	---
	235-250	---

Table 2
Torque Guidelines for Angle-pad Rigid Couplings

Size in	1512 N-m/Lbs-ft	GKS N-m/Lbs-ft	XGQT4 N-m/Lbs-ft
1	---	60-70	60-70
	---	45-50	45-50
1-1/4	60-70	60-70	60-70
	45-50	45-50	45-50
1-1/2	60-70	60-70	60-70
	45-50	45-50	45-50
2	60-70	60-70	60-70
	45-50	45-50	45-50
2-1/2	90-100	60-70	60-70
	65-75	45-50	45-50
3	90-100	60-70	90-100
	65-75	45-50	65-75
4	90-100	90-100	90-100
	65-75	65-75	65-75
5	200-230	90-100	90-100
	145-170	65-75	65-75
6	200-230	90-100	200-230
	145-170	65-75	145-170
8	270-300	200-230	200-230
	200-220	145-170	145-170
10	270-300	270-300	---
	200-220	200-220	---
12	270-300	270-300	---
	200-220	200-220	---
14	---	270-300	---
	---	200-220	---
16	---	270-300	---
	---	200-220	---

Do not attempt to add further torque after the bolt pads make metal to metal contact.

If the bolt pads do not make full metal to metal contact, increase the torque to the listed guideline in table 2. Do not exceed the listed torque by more than 25%, as excessive torque could lead to joint failure. If bolt pad gaps still exist after bolts and nuts have been tightened to the guideline torque, then this would indicate a problem in the assembly, pipe and or groove dimensions.

T&G (Tongue & Groove) RIGID COUPLINGS

The T&G style rigid coupling features a mechanical interlock mechanism and, while the bolt pads have been designed to meet metal to metal, a slight and equal gap between the bolt pads is acceptable as the T&G mechanism fully protects the gasket. The listed values in the table 3 are guideline torque values listed by the coupling size. Please note these are only guidelines and that the actual torque value may be less than those listed to achieve a proper assembly. Do not attempt to add further torque after the bolt pads make metal to metal contact.

If the bolt pads do not make full metal to metal contact, increase the torque to the listed guideline in table 3. Do not exceed the listed torque by more than 25%, as excessive torque could lead to joint failure. If excessive bolt pad gaps (in excess of 1/8" or 3.2mm) still exist after bolts and nuts have been tightened to the guideline torque, then this would indicate a problem in the assembly, pipe and or groove dimensions.

Table 3
Torque Guidelines for T&G Rigid Couplings

Size in	XGQT1 N-m/Lbs-ft	31HP N-m/Lbs-ft
1	60-70	---
	45-50	---
1-1/4	60-70	---
	45-50	---
1-1/2	60-70	---
	45-50	---
2	60-70	120-130
	45-50	90-95
2-1/2	60-70	120-130
	45-50	90-95
3	60-70	120-130
	45-50	90-95
4	90-100	200-220
	65-75	145-160
5	90-100	---
	65-75	---
6	90-100	---
	65-75	---
8	200-230(JIS216 270-300)	---
	145-170 (JIS216 200-220)	---
10	270-300	---
	200-220	---
12	270-300	---
	200-220	---

PLAIN-END COUPLINGS

Always tighten the bolts and nuts to the torques listed in the Table 4. Please note that the "Torque Requirements" are actual requirements for proper joint assembly and performance. These requirements values should not be exceeded by more than 25%, as excessive torque could lead joint failure.

Table 4
Torque Requirements for
Plain-End Couplings

Size in	HDP N=m/Lbs - ft
2	60 - 70
	45 - 50
3	90 - 100
	65 - 75
4	90 - 100
	65 - 75
6	200 - 230
	145 - 170
8	200 - 230
	145 - 170
10	200 - 230
	145 - 170
12	270 - 300
	200 - 220

For items and or sizes not listed, contact Lede or refer to the Lede installation instructions.

IMPORTANT CHECK POINTS

- Check to make sure the coupling is the correct size for the pipe and or fitting being connected.
- Check to make sure the coupling keys are fully engaged in the grooves.
- Check to ensure the gasket is not pinched, if so disassemble and reinstall.
- Check to ensure the bolts and nuts are fully tightened.
- Check to ensure the grooves conform to the applicable specification. If the groove is found to be too shallow or too deep, replace this section of pipe with one that conforms to the applicable groove specification.

Controlling Provisions:

These terms and conditions shall control with respect to any and all purchase orders or sales of Lede products.

No alteration, modification or waiver of these terms and conditions whether on the customer's purchase order or otherwise shall be valid unless the alteration, modification or waiver is specifically accepted in writing by an authorized representative of Lede Piping Products, Inc.

Shipping Terms:

All orders are quoted F.O.B. shipping point unless otherwise agreed upon in writing.

Orders are accepted subject to approval by our Head Office and Credit Department and are contingent upon acts of God, war, civil unrest or disturbance, strikes, labor difficulties, governmental regulations or rulings, delays of carriers (land, air or ocean), inability to obtain materials, accidents or any other cause beyond our control.

Shipping dates are estimated, and we will do our best to ship within the time estimated. We cannot guarantee shipping dates, and in the event of a production or shipment delay, we reserve the right to change the estimated shipping date. Under no circumstances shall Lede be liable for damages of any kind, including but not limited to incidental or consequential damages for lost sales or profits or liquidated damages, directly or indirectly arising from delays or failure to meet shipping dates.

Orders accepted cannot be changed or cancelled without our written consent.

Orders for special (non-standard) goods may not be cancelled, nor will we accept return of these goods for credit.

Claims For Shortages:

All claims for shortages must be made within 10 days of receipt of goods. Our responsibility ceases when the goods are delivered to the carrier in good condition. Carriers are responsible for goods lost, damaged or delayed in transit. For your own protection have the transportation company's agent verify any damage, shortage or delay and note them on the freight bill over his/her signature.

Weights:

All weights are approximate and subject to change without notice.

Always specify gasket grade when ordering and double check the gasket grade received to be sure it is suited for the service intended.

We reserves the right to change or modify product designs, specifications and/or standard equipment without notice and without incurring obligation. Prices and Terms and Conditions of Sale are subject to change without notice.

Warranty:

We warrant all Lede products to be free from defects in materials and workmanship under normal conditions of use and service. Our obligation under this warranty is limited to repairing at our option at our factory or designated facility any product which shall within 10 years after delivery to the original buyer be returned with transportation charges prepaid, and which our examination and inspection shall show to our satisfaction to have been defective.

This warranty is made expressly in lieu of any other warranties, express or implied, including any implied warranty of merchantability or fitness for a particular purpose. The buyer's sole and exclusive remedy shall be for the replacement or repair of defective products as provided herein. The buyer agrees that no other remedy (including but not limited of), incidental or consequential damages for lost profits, lost sales, injury to person or property or any other incidental or consequential loss shall be available to him/her.

We neither assumes nor authorizes any person to assume for it any other liability in connection with the sale of such products.

This warranty shall not apply to any product which has been the subject to misuse, negligence or accident, which has been repaired or altered in any manner outside of Lede's factory or designated facility or which has been used in a manner contrary to Lede's instructions, recommendations or generally accepted practices. Lede shall not be responsible for design errors due to inaccurate or incomplete information supplied by the buyer or his representatives. (Effective July 1, 1998)

PREM

Tel: +86-536-8167992

Fax: +86-536-8167916

Email: admin@ledgroup.cn

Web: www.led-group.com

Add: No. 3998, Xi Wai Huan Road, Weifang City 261057, Shandong Province, P.R.China